











EXOGEN[®] User Guide

Read before using your device



EXOGEN Label Symbol Descriptions and Equipment Classification

	Information Symbol: refer to User Guide.
	Catalog Number
	CE Mark: indicates conformity with European Council Directive of 14 June 1993 concerning Medical Devices (93/42/EEC).
	Type BF Applied Part. The transducer, shown in Figure 2 on page 2 is an applied part.
	Not for General Waste. This symbol indicates that EXOGEN should not be disposed of with ordinary household waste at the end of its life. For details on how to dispose of this device correctly, contact your local government waste disposal agency or your local Bioventus representative.
	Manufacturer
	This symbol indicates the authorized representative in the European Community.
	Serial number (first four digits of the serial number indicate the month and year of manufacture)
	Pulsed Signal
	Rx Symbol: Federal Law (U.S.A.) restricts this device to sale, distribution, or use by or on the order of a physician or properly licensed practitioner. This device is only intended for use by the individual for whom it is prescribed.

Caution

Federal Law (U.S.A.) restricts this device to sale, distribution, or use by or on the order of a physician or properly licensed practitioner. EXOGEN is only intended for use by the individual for whom it is prescribed. EXOGEN is for single patient use ONLY.

THIS DEVICE IS NON-STERILE.
It does not require sterilization before use.

EXOGEN is a Class B digital apparatus which meets all requirements of the Canadian Interference-Causing Equipment Regulations.

Table of Contents

EXOGEN Overview	1	EXOGEN Care	17
Indications for Use	1	Operating Conditions	17
EXOGEN Description	1	Storage	17
EXOGEN Device (EXOGEN)	2	EXOGEN Expected Service Life	17
Charger (power supply)	2	Battery and Charging Safety	18
Strap	2	EXOGEN Disposal	19
Ultrasound Coupling Gel	3	Removing the Battery for Disposal	19
Important Things to Know	3		
EXOGEN Usage	3	Troubleshooting	20
Contraindications	3	Clinical Studies	21
Warnings	3	Metal and Implants	21
Precautions	4	Mechanism of Action	21
Display Symbols and Descriptions	4	Adverse Events	21
Getting Started	5	Complications	21
Charging EXOGEN	5	References	22
Recharging EXOGEN	6	Technical Information	23
Preparing to Treat Your Fracture	7	EXOGEN Classifications	24
Place the Strap	7	Guidance and Manufacturer's Declaration	24
If You Have a Cast	8	Customer Service	28
Add Gel and Place Transducer	8	Limited Warranty	28
EXOGEN Setup	9		
First Use	9		
Hour Setting	9		
Treating Your Fracture			
Start Treatment	10		
EXOGEN Cleaning	11		
Tracking Your Treatment	13		
Track Usage	13		
Treatment Calendar	13		
Treatment Summary Data	14		
Treatment History	15		
Calendar Pause	16		

EXOGEN Overview

Indications for Use

EXOGEN Ultrasound Bone Healing System is indicated for the non-invasive treatment of osseous defects (excluding vertebra and skull) that includes:

- Treatment of delayed unions and nonunions¹
- Accelerating the time to heal of fresh fractures
- Treatment of stress fractures
- Accelerating repair following osteotomy
- Accelerating repair in bone transport procedures
- Accelerating repair in distraction osteogenesis procedures
- Treatment of joint fusion

¹A nonunion is considered to be established when the fracture site shows no visibly progressive signs of healing.

EXOGEN Description

The EXOGEN Ultrasound Bone Healing System provides non-invasive therapy for healing nonunions and accelerating time to healing of fresh fractures. EXOGEN can be used on both fresh fractures and nonunions – and both can be conservatively or surgically treated. EXOGEN transmits a low-intensity pulsed ultrasound signal to the fracture site through coupling gel, with little or no sensation felt by the patient during the treatment. Low-intensity pulsed ultrasound has been shown in in-vitro and in-vivo studies to stimulate cells to produce growth factors and proteins that are important to bone healing.

The patient administers treatment at home or at work, once daily, for 20 minutes, or as prescribed by a physician. EXOGEN automatically alerts the patient in case of improper application or performance. The EXOGEN Ultrasound Bone Healing System consists of one EXOGEN device, a charger, a gel bottle and strap. The EXOGEN device provides the treatment control circuitry, the battery supply and monitors the operation of the transducer at the fracture site. The signal specifications cannot be changed.

Everything you need to treat your fracture is included in the EXOGEN Ultrasound Bone Healing System. (See **Figure 1**). If one of the items in **Figure 1** is missing, please contact Customer Service at **1-855-771-0606** to receive a replacement.

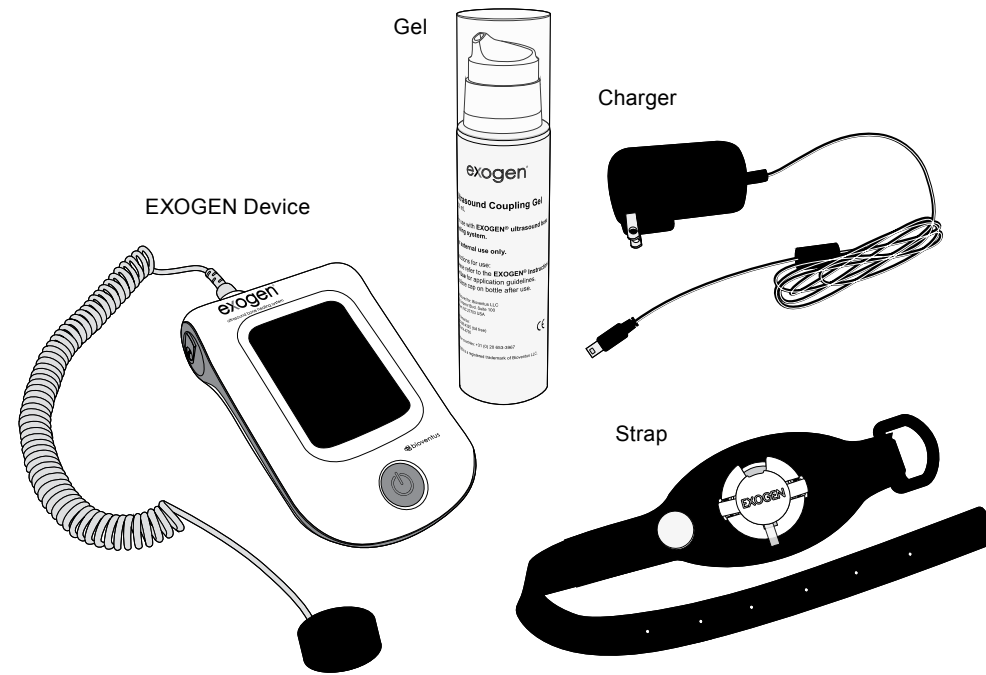

Figure 1: EXOGEN Ultrasound Bone Healing System

EXOGEN Device (EXOGEN)

EXOGEN (**Figure 2**) features a transducer at the end of a coiled cord, colour screen, power button and USB charging port. The cord and transducer are not removable from EXOGEN.

EXOGEN contains the internal electronics and battery. It checks the ultrasound signal to make sure EXOGEN works properly. The transducer sends low-intensity pulsed ultrasound to the fracture site through the gel. EXOGEN can also sense if gel is present on the transducer surface.

EXOGEN stores and displays a calendar of daily use. This data is available to you and your physician.

EXOGEN has a mini-USB charging port to allow you to recharge the battery. EXOGEN will not communicate with any other electrical devices.

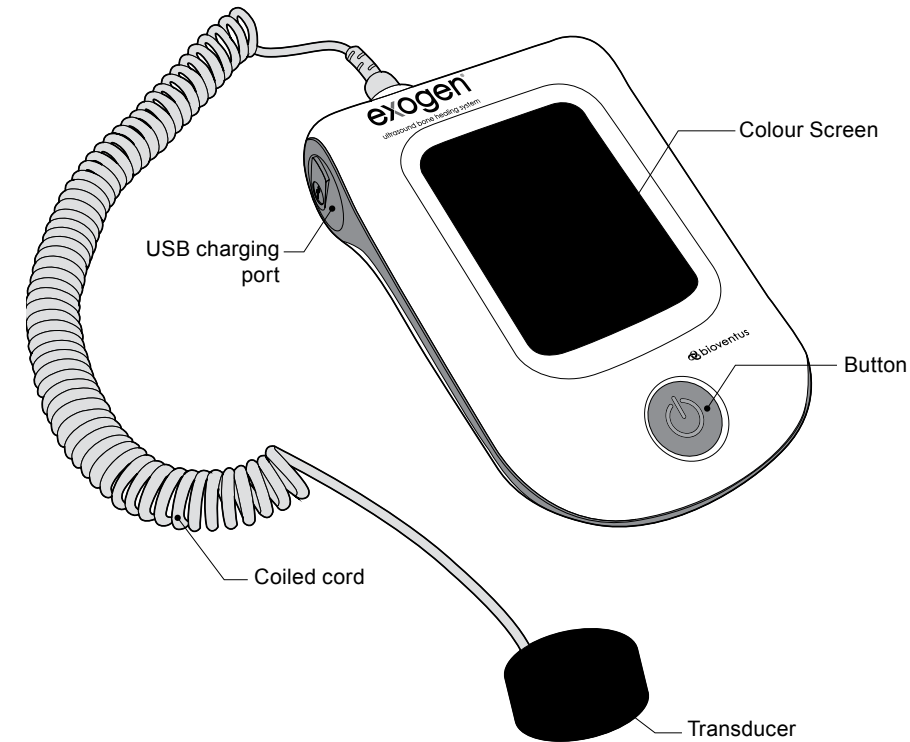

Figure 2 – EXOGEN Device (Part Number: 71034401)

Charger (power supply)

EXOGEN is powered by a rechargeable battery. A charger (**Figure 3**) is included with EXOGEN. Only use this supplied charger with EXOGEN. Do not plug other chargers into EXOGEN. Other chargers may cause injury to you or others near EXOGEN as well as damage to the charger. The use of chargers, transducers or cables, other than those supplied, may result in increased radiofrequency emissions or decreased electromagnetic immunity of the EXOGEN which may cause EXOGEN to stop working.

The USB plug end of the cord plugs into EXOGEN. The other end plugs into a wall outlet. The charger requires a standard North American 120 VAC, 60 Hz, household electrical outlet.

Read more about how to charge EXOGEN in “Getting Started” on page 5.

Figure 3 – EXOGEN Charger (Part Number: 71034460)



Strap

The strap (**Figure 4**) is used to position the transducer over your treatment site. The strap has a port in it to hold the transducer in place. The cap holds the transducer down on the treatment site. The strap is adjustable to fit most fracture locations. If your strap does not fit the location of your fracture, please contact Customer Service at **1-855-771-0606** to find out if there is another strap which may fit better.

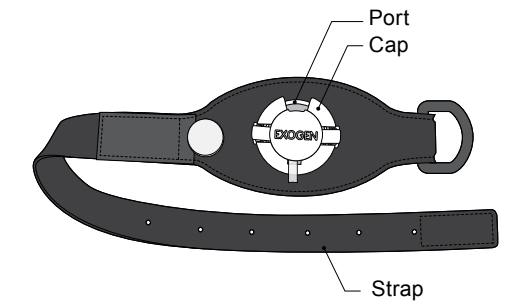

Figure 4 – EXOGEN Strap (Part Number: 71034622)

Ultrasound Coupling Gel

Ultrasound coupling gel (**Figure 5**) is provided for use with EXOGEN. The gel is to be placed on the transducer every time you use EXOGEN. The gel lets the ultrasound signal reach your fracture through your skin. EXOGEN will not work properly if gel is not covering the transducer and you will receive an alert from EXOGEN.

Only use the gel supplied. Do not use other gels as they may damage the transducer surface or block the signal. If you need more gel, please call Customer Service at **1-855-771-0606**.

Note: Some patients have experienced mild skin irritation caused by skin sensitivity to the gel. If you feel your skin is sensitive to the gel, you may change the gel to mineral oil or glycerin.



Figure 5 – Ultrasound Coupling Gel
(Part Number: 71034694)

Important Things to Know

EXOGEN is approved for use by persons that are 18 years or older and skeletally mature. There is no maximum age limit to using EXOGEN. The anticipated education level of an EXOGEN user is to read English at an 8th Grade level or equivalent, and the ability to read and understand Western Arabic numerals. No special previous experience or skills are needed or expected to be able to operate EXOGEN. There may be physical impairments that result from the presence of a fracture, such as reduced range of motion or immobility. EXOGEN is expected to be used with one hand for guiding and holding EXOGEN.

Read “Getting Started” (page 5) and “Treating Your Fracture” (page 10) before you begin using EXOGEN.

EXOGEN Usage

EXOGEN should be used for 20 minutes per day or as prescribed by your doctor. It is important that you use EXOGEN as prescribed by your doctor to get the full benefit of the treatment. Your doctor will decide when your fracture is healed. Every fracture is different and it takes some fractures longer to heal than others. Call your doctor if you have questions or concerns about your fracture.

EXOGEN is for single patient use only. EXOGEN will deliver 343 full 20-minute treatments. If this number is reached and you are still treating your fracture under your doctor’s direction, contact Customer Service at **1-855-771-0606** for instructions.

Contraindications

There are no known contraindications to the use of EXOGEN.

Warnings

The safety and effectiveness of the use of EXOGEN has not been established for:

- Fractures with post-reduction displacement of more than 50% (i.e., fractures in which the opposing broken bone ends are out of alignment by more than one half of the width of the bone)
- Pathological fractures due to bone pathology or malignancy (fractures due to disease)
- Pregnant or nursing women
- Individuals with thrombophlebitis (blood clot in a vein), vascular insufficiency (poor blood supply), abnormal skin sensitivity (very sensitive skin), sensory paralysis (lack of sensation), alcoholism and/or nutritional deficiency
- Individuals receiving steroid, anticoagulant, prescription non-steroidal anti-inflammatory, calcium channel blocker and/or diphosphonate therapy. Individuals using these therapies were excluded from the studies because of the possible effects of these therapies on bone metabolism
- Nonunions of the vertebra and the skull
- Individuals lacking skeletal maturity
- The safety of EXOGEN when used around acute elbow injuries has not been established. A potential risk exists for aggravation of heterotopic bone formation.

Precautions

- EXOGEN will not correct or alter post-reduction (when your fracture is initially set and placed in a cast) aspects of a fracture such as displacement, angulation or malalignment.
- The transducer, strap and gel are not sterile and placement on an open wound is not advised.
- The operation of active, implantable devices, such as cardiac pacemakers may be adversely affected by close exposure to EXOGEN. The physician should advise the patient or other person in close proximity during treatment to be evaluated by the attending cardiologist or physician before starting treatment with EXOGEN.
- The cords pose a risk for strangulation. Keep out of reach of children.
- Cell phones, televisions, and other devices using radiofrequency energy may cause interference. This interference may cause EXOGEN to operate improperly or stop operating completely. While EXOGEN complies with the limits for Class B digital devices pursuant to Part 15 of the FCC rules, it has not been studied with all brands and models of phone.
- The safety and effectiveness of EXOGEN when used for more than one daily 20-minute treatment period has not been studied.
- For single patient use **ONLY**. The risk of use between multiple patients includes but is not limited to cross contamination between patients as cleaning agents and solvents are not recommended for cleaning the transducer.
- When choosing a treatment site ensure that the site selected allows for full contact of the transducer face with the skin. Failure to do so may result in the transducer being only partially coupled to the skin. This may reduce the effectiveness of EXOGEN in treating the fracture.

Display Symbols and Descriptions

Symbol	Name	Description
	Charging Symbol	Flashes to show EXOGEN is plugged in and charging.
	Battery Status	Shows how much charge is left in the battery.
	Calendar X-Mark	A 20-minute treatment was not completed on this calendar day.
	Calendar Checkmark	A 20-minute treatment was completed on this calendar day.
	Calendar Double Checkmark*	Two 20-minute treatments were completed on this calendar day.
	Calendar Double Checkmark Plus*	Three or more 20-minute treatments were completed on this calendar day.
	Treatment Symbol	Flashes during use to show you are treating your fracture.
20:00	Countdown Timer	Counts down from 20 minutes to show treatment time remaining.
	Treatment Complete	Automatically displays when countdown timer reaches zero to show that treatment is complete.

*EXOGEN should be used for only 20 minutes per day, or as prescribed by your doctor.

Getting Started

Charging EXOGEN

EXOGEN has a rechargeable lithium-ion battery. A fully-charged battery delivers approximately five 20-minute treatments. It takes about 5 hours to fully charge a discharged EXOGEN battery.

WARNING: To avoid the risk of electric shock, EXOGEN must only be connected to a supply mains with protective earth (a 3-prong electrical outlet). Do not use any adapters or extension cords to charge EXOGEN. Only plug the charger into an UL listed electrical outlet.

Charge EXOGEN before you begin a treatment or turn EXOGEN on. Follow the steps below to charge EXOGEN:

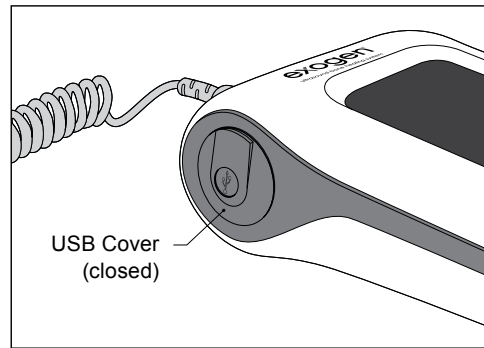

1. Find the USB cover on the left side of EXOGEN.

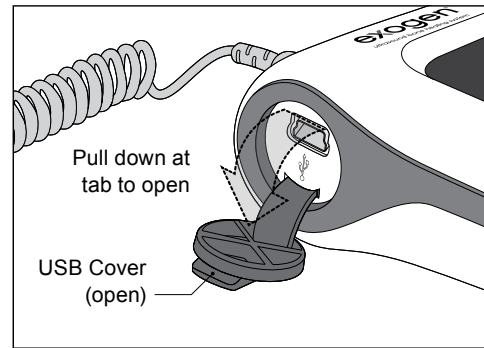

2. Pull the tab down to open the USB cover.

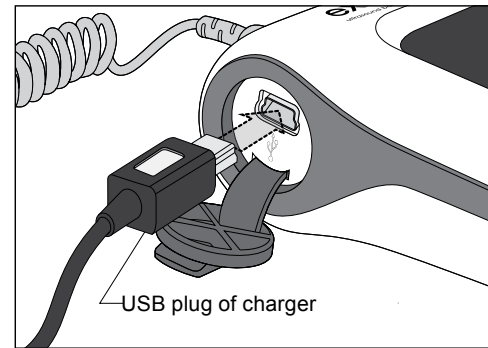

3. Plug the end of the charger into an electrical outlet. Plug the USB plug end of the charger into the USB port.

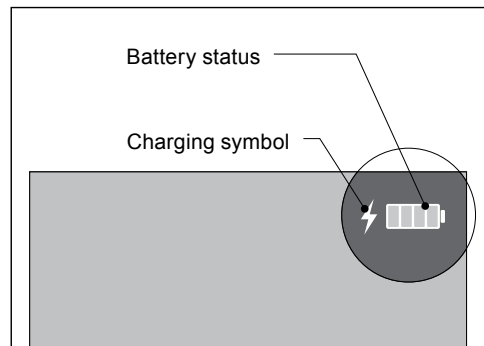

4. You will see the charging symbol (white lightning bolt) and battery status symbol flashing in the corner of the screen. This lightning bolt charging symbol tells you EXOGEN is charging. Charge EXOGEN until a fully-charged battery is shown by the battery status. (**Figure 6**)

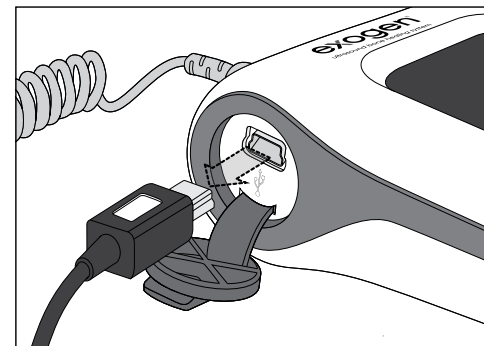

5. When charging is complete, remove the USB plug from EXOGEN, close the USB cover and unplug the charger from the wall.

As you use EXOGEN, the symbol will change to show the reduced battery level. See **Figure 6**.

Battery Charge Levels

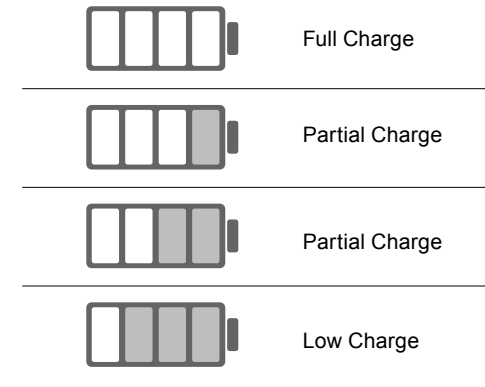

Figure 6 – Battery Status Symbols

You may charge EXOGEN at any time, whether it is on or off. When the battery level is low, you must charge EXOGEN before your next treatment.

You can charge EXOGEN and treat your fracture at the same time. Use the charger provided in the EXOGEN Ultrasound Bone Healing System.

Do not connect EXOGEN to any other electrical equipment. EXOGEN is unable to communicate with any other electrical equipment.

BATTERY PROBLEM?

Try fully charging EXOGEN with the charger provided. If your EXOGEN unit still does not work, call Customer Service at **1-855-771-0606**. Do not try to fix EXOGEN yourself.

Recharging EXOGEN

Check the charge level on EXOGEN following treatment. If the battery is low, charge EXOGEN with the supplied charger. See the “Charging EXOGEN” (page 5) for instruction on charging EXOGEN.

Preparing to Treat Your Fracture

To treat your fracture, you will need EXOGEN, the gel and strap. If you have a cast around your fracture, you will not need the strap.

Your doctor may have marked your fracture site with an 'X', or told you where to treat your fracture. This is the spot to place the transducer to treat your fracture. Contact your doctor if you are not sure where to treat your fracture.

Before you begin, check the cable and the transducer for any cracks or signs of damage. If damaged, do not use EXOGEN and contact Customer Service at **1-855-771-0606**.

Precaution: The transducer, strap and gel are not sterile and placement on an open wound is not advised.

If you have a cast, proceed to "If You Have a Cast" (page 8).

Place the Strap

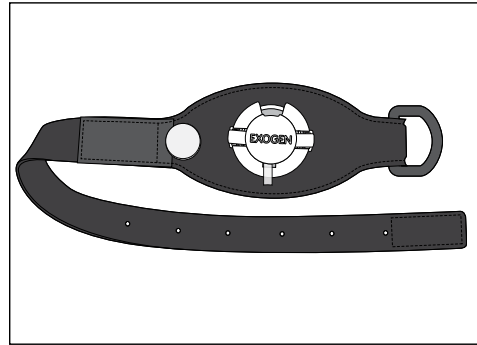

1. Position the strap with the cap facing up.

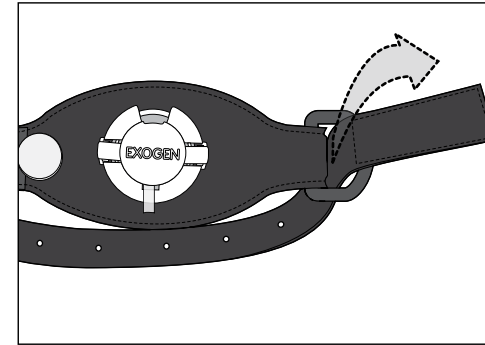

2. Pull the long end of the strap through the plastic loop, as shown.

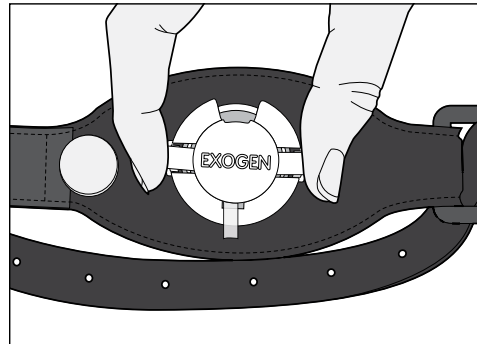

3. Use 2 fingers to squeeze the cap tabs together to open the cap.

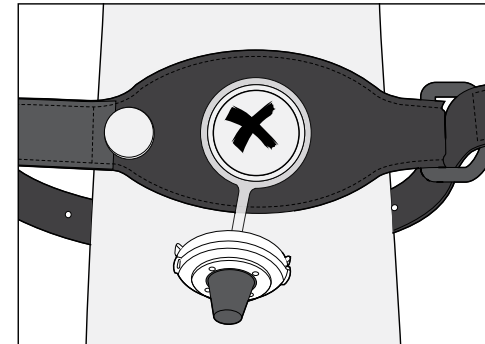

4. Slide on the strap and place the port over the 'X' mark on your skin.

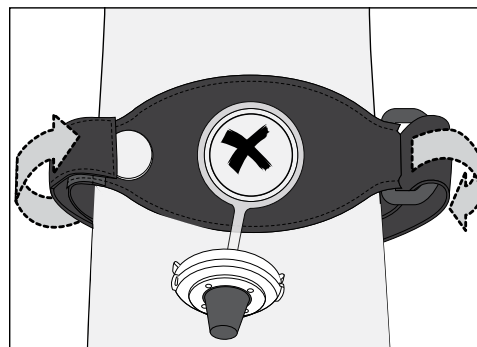

5. Tighten the strap by pulling on the long end. Fasten the strap in place. Do not make the strap too tight!

» Continue to "Add Gel and Place Transducer"

If You Have a Cast

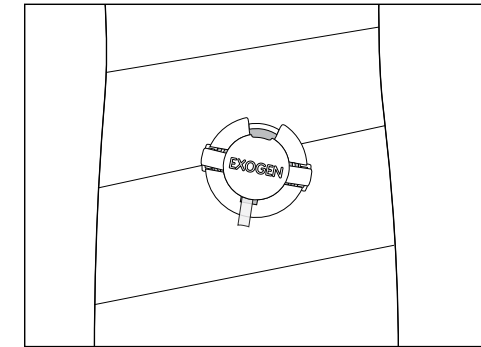

1. Your cast will have a plastic port with cap built into it.

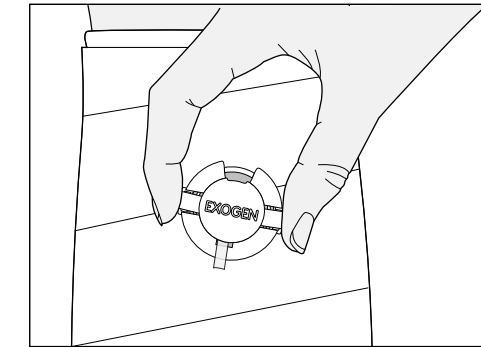

2. Use 2 fingers to squeeze the cap tabs together to open the cap.

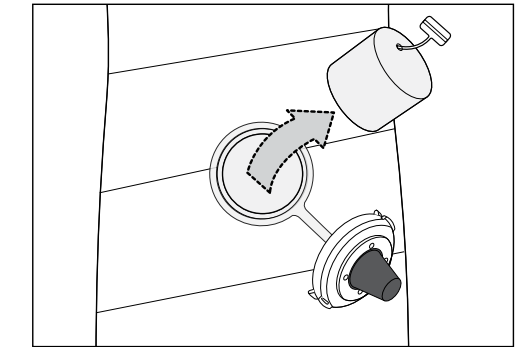

3. Pull out the round felt plug inside the opening.

Add Gel and Place Transducer

Note: Some patients have experienced mild skin irritation caused by skin sensitivity to the gel. If you feel your skin is sensitive to the gel, you may change the gel to mineral oil or glycerin.

Add gel on the transducer every time you treat your fracture.

1. Take the cap off the gel bottle.
2. Hold the transducer so the cord is down and the smooth side of the transducer is up.

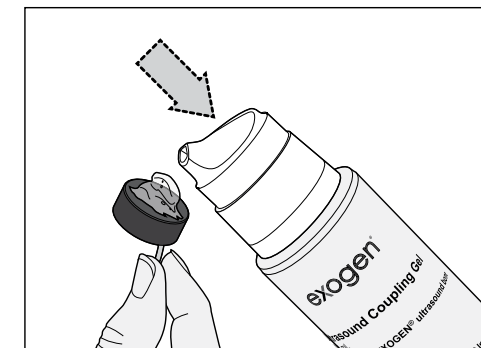

3. Press down on the gel bottle nozzle to put gel on the smooth side of the transducer. You only need one full pump of gel on the transducer. (**Note:** The first time you use the gel, you may need to pump a few times to start the gel flowing.)

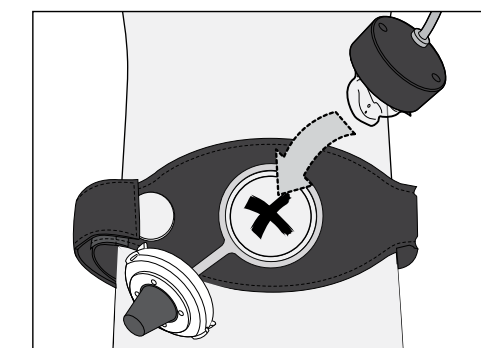

4. Put the transducer, gel side down, into the port. The gel will be touching the skin over your treatment site.

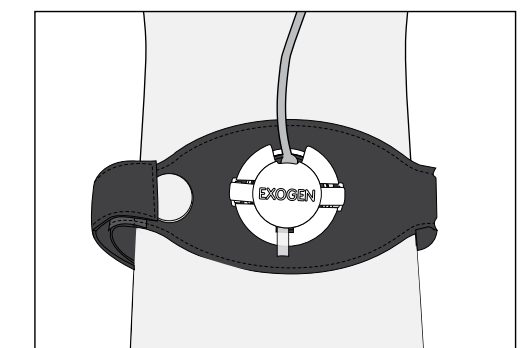

5. Align the cord coming out of the transducer with the notch in the cap. Snap the cap shut on the strap or the cast.
6. Replace the cap on the gel bottle.

» Continue to "First Use" or "Start Treatment"

EXOGEN Setup

First Use

EXOGEN has a calendar which tracks how often the system is used. The current hour needs to be set to make sure the calendar is accurate. The hour must be set once, the very first time EXOGEN is turned on.

Hour Setting

1. Press the button once. The hour and AM/PM show on the screen. This may or may not be your current hour. The clock must be set to your current hour. For example, if your time is anywhere between 2:00 PM and 2:59 PM, set the hour to 2 PM.

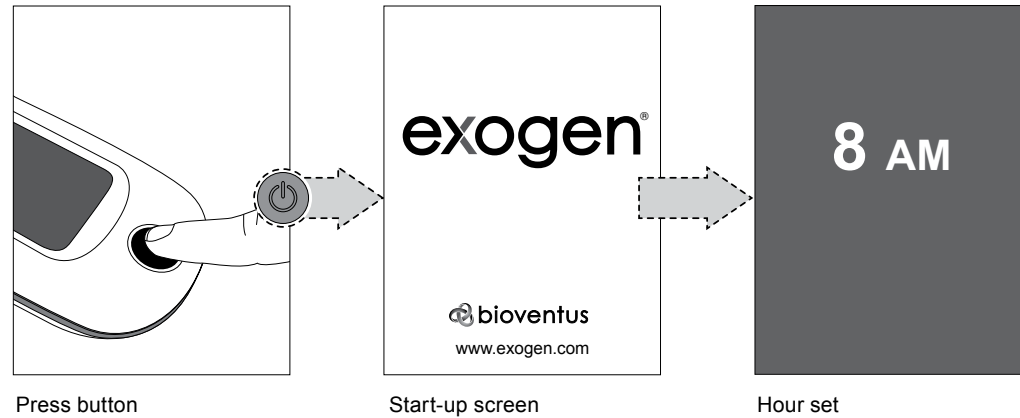

2. Press the button once to advance the time one hour. Press the button, one press at a time, until the correct hour and AM/PM is displayed on the screen.

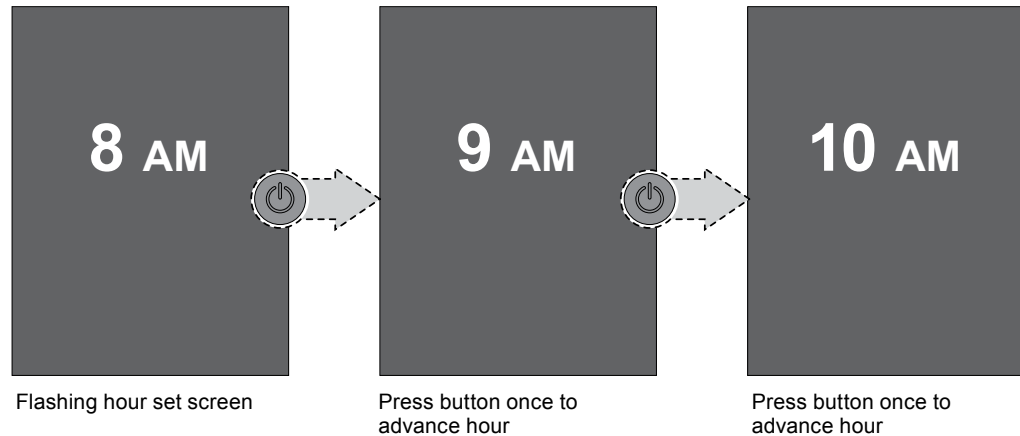

3. **Press and hold** button until you see the hour confirmation screen. This indicates that the hour has been set on EXOGEN. You do not need to set the minutes. After 5 seconds the device will automatically turn off.

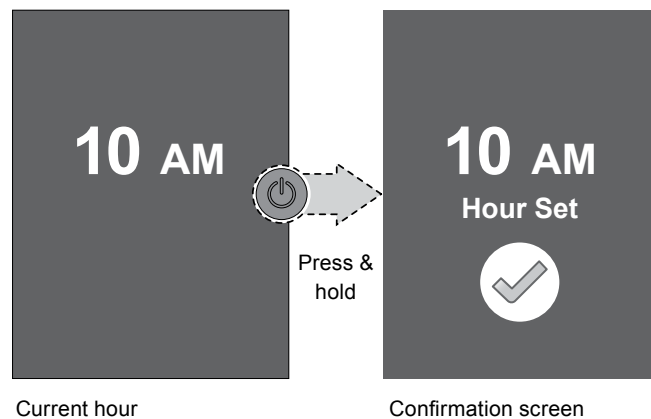

Contact Customer Service at **1-855-771-0606** if you have incorrectly set the hour and would like to reset it.

Note: EXOGEN will effectively deliver treatment even if the correct hour is not selected.

Treating Your Fracture

Start Treatment

Hold EXOGEN in your hand to view the screen, or set EXOGEN down on a nearby flat surface. Perform the following steps to begin treatment:

1. Press the button on EXOGEN. EXOGEN beeps and the start-up screen appears for 2 seconds.
2. A calendar appears on the screen for 5 seconds. It shows the current month and your treatment summary. For more information on the calendar screen, see "Tracking Your Treatment" on page 13.
3. Next, the 20-minute countdown timer appears on the screen. EXOGEN automatically begins the ultrasound treatment. A treatment symbol flashes as the timer counts down. This means you are treating your fracture. (Note: To stop EXOGEN in the middle of the 20-minute treatment, press and hold the button until EXOGEN turns off.) If your EXOGEN has an error during treatment, see "Troubleshooting" on page 20.
4. When the countdown timer reaches zero, EXOGEN beeps and shows the treatment complete checkmark. The treatment complete checkmark displays for 5 seconds. Then, the device will automatically turn off.

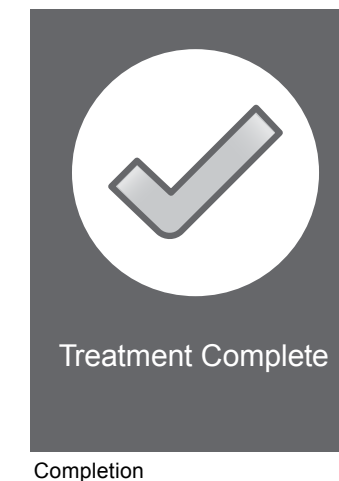
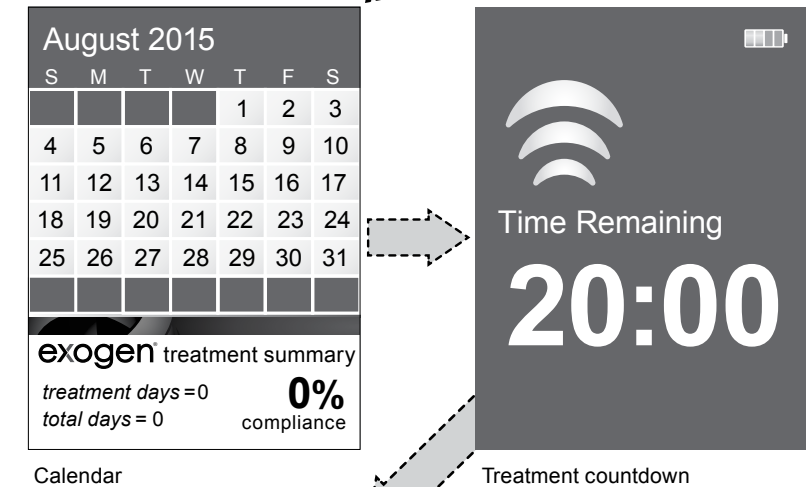
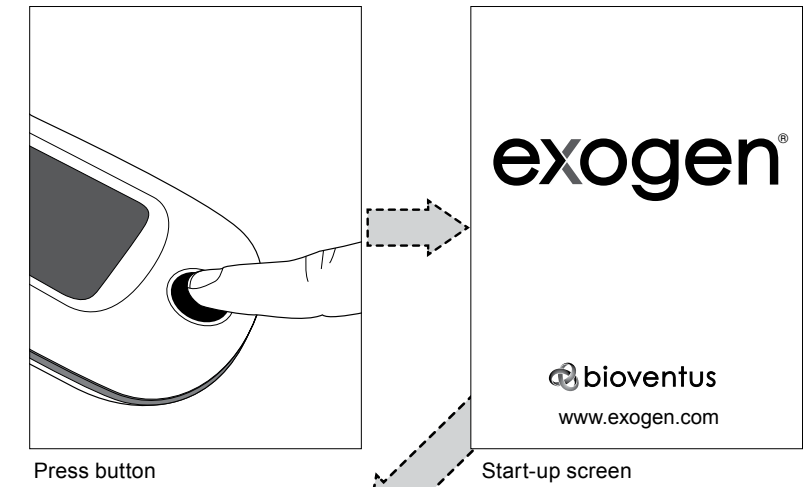

EXOGEN Cleaning

After treatment is complete, you must clean the transducer after each use.

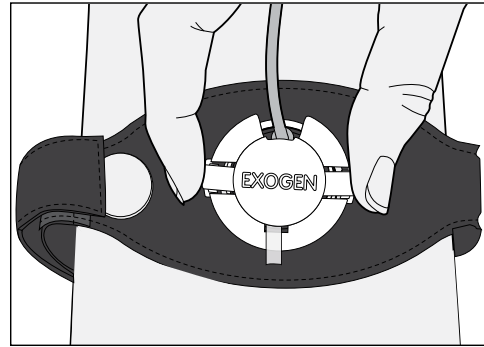

1. Squeeze tabs to open the cap on the port.

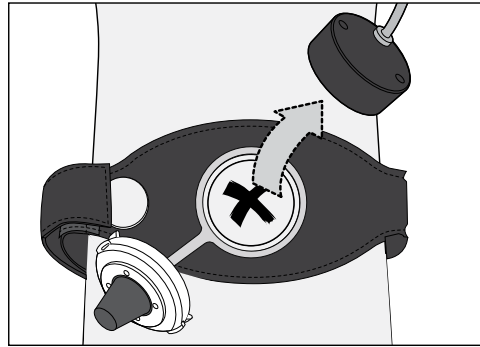

2. Gently remove the transducer from the port. Do not yank the cord! Pulling hard on the cord to remove the transducer may cause the cord to detach from the transducer.

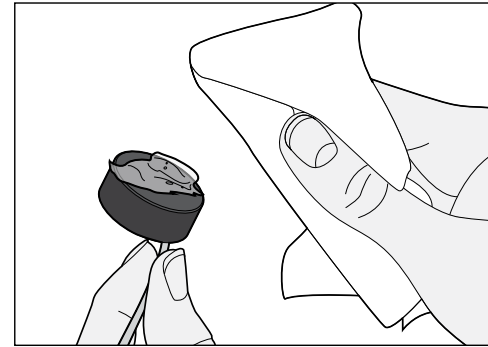

3. Wipe off any gel on the transducer with a soft cloth. You do not need any cleaning fluid.

If You Have a Cast

Follow steps 1-3 (previous page), and then do the following instead of step 4:

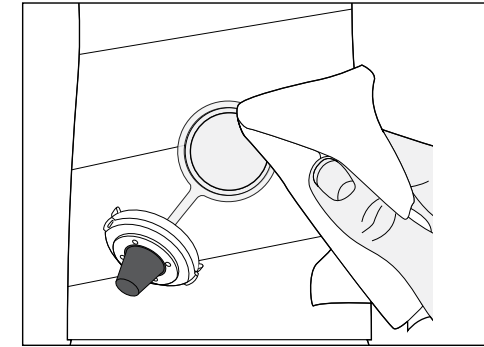

4. Carefully clean any gel from your cast, skin and port with a soft cloth.

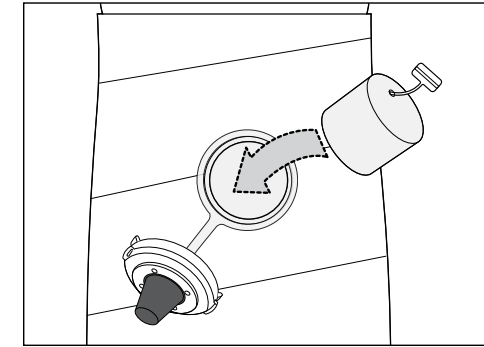

5. Insert the felt plug, with the tab up, into the port. This plug helps prevent swelling in the cast when you are not using EXOGEN.

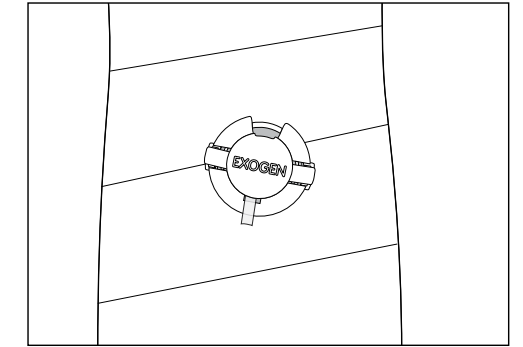

6. Snap the cap shut.
7. Place EXOGEN and the gel back into the carrying case until you are ready to treat again.

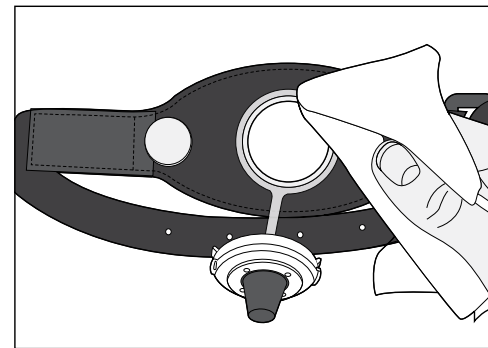

4. Remove the strap and clean any gel from your skin and strap with a soft cloth.
5. Place EXOGEN, the strap and gel back into the carrying case until you are ready to treat again.

Tracking Your Treatment

Track Usage

EXOGEN tracks how often you use it. A calendar shows your usage on the screen. There are two parts to the calendar screen. The top part shows a calendar month and the bottom part shows the treatment summary information. See Figure 7.

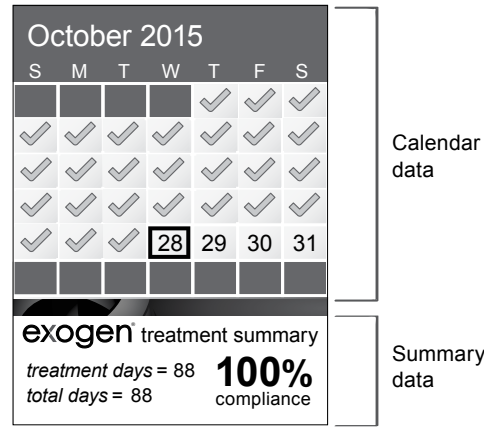

Figure 7 – Treatment Calendar

Treatment Calendar

The current month is shown when you turn on EXOGEN for a treatment. Today's date will have a purple box around it. EXOGEN will mark your calendar every day with one of the following symbols: X-mark, checkmark, double checkmark*, or double checkmark plus.*

Symbol	Name	Description
	X-mark	You did not complete a 20 minute treatment on this day.
	Checkmark	You completed a 20 minute treatment on this day.
	Double checkmark	You completed two 20 minute treatments on this day.
	Double checkmark plus	You completed three or more 20 minute treatments on this day.

*EXOGEN should be used for only 20 minutes per day, or as prescribed by your doctor.

Treatment Summary Data

The treatment summary shows your overall use of EXOGEN. The summary data always accounts for all your days of treatment, not just the current month.

Treatment days are the number of days that you have completed a 20-minute treatment. This includes days marked with a checkmark, double checkmark, or double checkmark plus.

Total days are the number of days passed since your first treatment.

The large compliance % is the number of treatment days divided by the number of total days.

For example, if you use EXOGEN every day for 60 days, you will have the following numbers:

Treatment days= 60

Total days= 60

Compliance= 100%

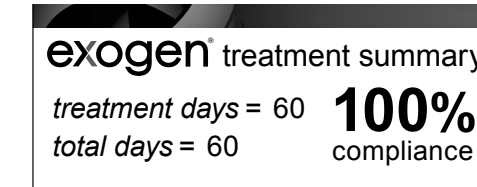

If you have EXOGEN for 60 days, but forgot to treat 10 of those days, your numbers will look like:

Treatment days= 50

Total days= 60

Compliance= 83%

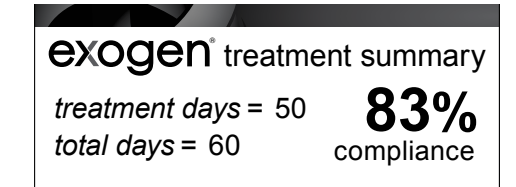

REMEMBER! Use EXOGEN every day for 20 minutes, or as directed by your doctor.

Treatment History

After using EXOGEN over time, you may want to view your treatment history month by month. EXOGEN will store up to twelve months of recent treatment history. You can show your treatment history to your doctor. EXOGEN lets you view your treatment history without having to start a treatment. You can start EXOGEN in "Treatment History" mode. You cannot enter "Treatment History" mode when EXOGEN is being charged. To view your treatment history, perform the following steps:

1. EXOGEN must be "OFF" and unplugged from the charger.
2. Press and hold the power button until the Treatment History screen appears.
3. Then, a calendar of the current month of treatment appears for 5 seconds.
4. EXOGEN then shows the previous month of treatment for 5 seconds. This continues until your most recent twelve months of treatment have been shown. Please note, if you have treated with EXOGEN for fewer than 12 months, the EXOGEN device will only display treatment history for the number of months you have used your device. This could be as few as one or two months. You may exit the Treatment History mode at any time by pressing and holding the button until EXOGEN turns itself off.
5. After the last month displays for 5 seconds, EXOGEN turns itself off.

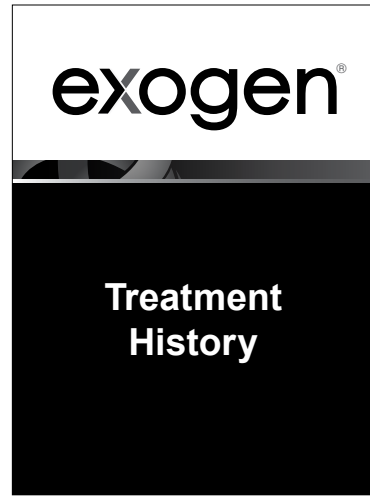

History start screen

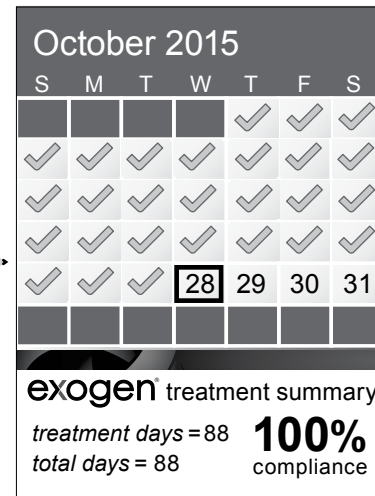

Calendar 1

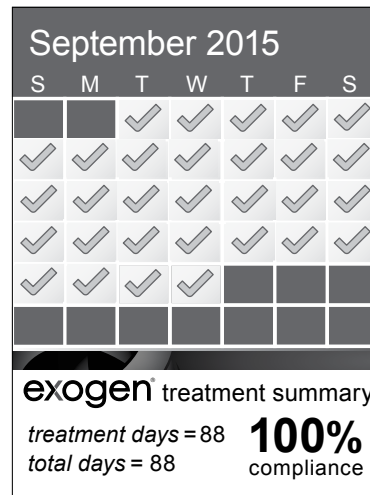

Calendar 2

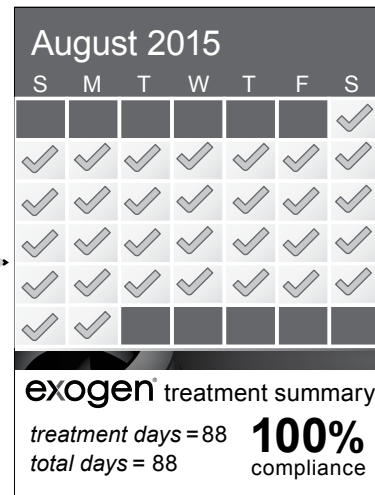

Calendar 3

Calendar Pause

You can pause the calendar screen to view your treatment history for longer than 5 seconds.

Any calendar screen can be paused. To pause the calendar, perform the following steps:

1. When you see a calendar screen, press the button to pause.
2. The calendar will pause, a pause symbol appears, and the word "PAUSED" flashes.
3. Press the button again to un-pause the calendar and continue.
4. The calendar screen will automatically un-pause after 2 minutes and continue.

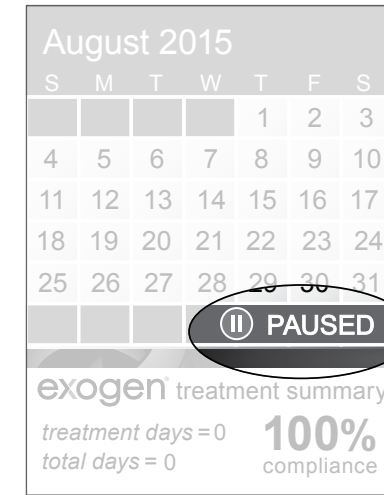

EXOGEN Care

EXOGEN should be handled with care. Please note the following:

- Use only a clean soft cloth, paper towel, or cotton swab to clean EXOGEN, the transducer and the strap. Do not use cleaning agents or solvents on any of the components of the system.
- Do not attempt to modify, disassemble or repair EXOGEN. There are no user serviceable parts inside EXOGEN.
- Exercise care when handling the transducer as rough handling may scratch the transducer face and cause EXOGEN not to work properly.
- If any parts of EXOGEN or its accessories are damaged, do not use EXOGEN. Please contact Customer Service at **1-855-771-0606**.
- EXOGEN is classified as an IP-22 device. The IP-22 classification indicates that EXOGEN provides:
 - Protection against the access of fingers or similar objects from the internal components of EXOGEN.
 - Protection against the harmful ingress of water into the enclosure of EXOGEN when tilted up to 15° from normal position.
- The EXOGEN transducer is classified as an IP-67 component. The IP-67 classification indicates that the transducer is:
 - Dust-tight
 - Will not be damaged by water under defined conditions of pressure and time (up to 1 meter underwater)
- Never put EXOGEN in or under water.

Operating Conditions

EXOGEN should be operated within:

Ambient temperature range: 5°C to 32°C (41°F to 89°F)

Relative humidity range: 15% to 75% (non-condensing)

Atmospheric pressure range: 700 hPA to 1060 hPA

Interference with proper operation of EXOGEN may occur in the vicinity of equipment such as portable and mobile communication units marked with this symbol . If abnormal operation of EXOGEN is observed, attempt to relocate or reorient EXOGEN in relation to the interfering equipment until the interference stops.

The charger will function with an input voltage range from 100 VAC -240 VAC and has an operating frequency range of 50/60 Hz. The charger output is 5 VDC.

EXOGEN and accessories should be stored and transported within:

Ambient temperature range: 0°C to 32°C (32°F to 89°F)

Relative humidity range: 15% to 75%

Atmospheric pressure range: 700 hPA to 1060 hPA

If EXOGEN is stored or transported in temperatures outside this range, allow EXOGEN time to come to room temperature for at least 30 minutes before operating. The least favorable working conditions for EXOGEN are +32°C at 75% Humidity.

Storage

- To prevent damage to EXOGEN and its accessories, store EXOGEN in its carrying case while not in use.
- Do not store EXOGEN near radiators or extreme heat.
- Do not expose EXOGEN to extreme temperatures or the internal electronic components may be damaged.
- As with any home electronic device, protect EXOGEN from impact, exposure to moisture, liquid spills, sand, dirt or debris.

After your fracture has healed or prior to long-term storage of EXOGEN, remove the battery to prevent leakage of the battery.

EXOGEN Expected Service Life

The expected service life of EXOGEN and its accessories is 343 treatments (6860 minutes). Once EXOGEN delivers 343 treatments, it will not provide further treatment.

Battery and Charging Safety

Battery

- Do not attempt to replace the lithium-ion battery.
- Do not attempt to replace the lithium-ion battery with non-approved batteries. Incorrect replacement of the battery could result in damage to EXOGEN. The battery should only be serviced by Bioventus trained personnel.
- Be sure to use only the USB battery charger (Part Number 71034460) provided with the system. Other battery chargers may cause battery overheating and damage the battery, EXOGEN, the battery chargers or the user.
- Do not use an extension cord with the battery charger as this may cause overheating.
- Do not use the battery charger with other devices as this may damage the battery charger and/or the other device.
- If the battery area on EXOGEN or the battery charger becomes excessively warm, discontinue using and contact Customer Service at **1-855-771-0606**.

Charging

- Charge the battery to at least 25% capacity (one bar) before attempting to perform a treatment when the battery is used for the first time or after prolonged storage.
- The battery will charge whether EXOGEN is turned off or on.
- If the battery power decreases quickly even after recharging for many hours contact Customer Service at **1-855-771-0606**.

Do not recharge the battery in any of the following locations;

- Where the ambient temperature is below 0°C or above 45°C
- Damp or wet location and/or near water
- Outside (charge indoors only)
- Within the reach of small children
- With the battery charger cable stretched across a floor or other areas where people walk that would cause a tripping hazard
- On floor or other area where EXOGEN or the cable may be damaged by people walking on them

EXOGEN Disposal

EXOGEN is designed for single patient use only. For details on how to dispose of EXOGEN correctly, contact your local government waste disposal agency or Customer Service at **1-855-771-0606**.

Caution: Dispose of the battery properly to prevent environmental contamination and possible human injury.

Warning: Do not throw any part of EXOGEN into fire.

Removing the Battery for Disposal

Only remove the battery from EXOGEN for disposal. To remove the battery, follow these steps:

1. Make sure EXOGEN is not plugged in to an electrical outlet.



2. Turn EXOGEN screen side down and find the battery door screw.

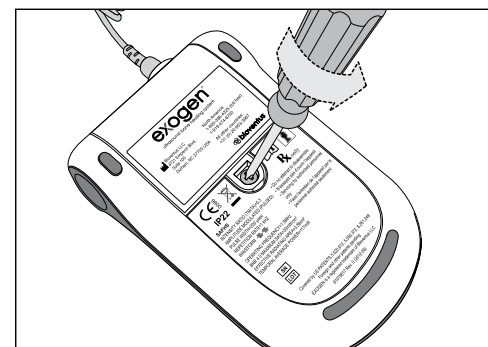

3. Use a screwdriver to remove the battery door screw.

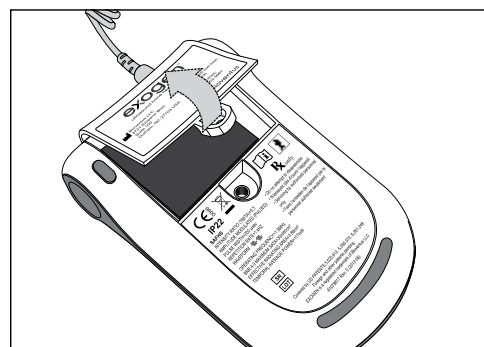

4. Remove the battery door by lifting up at the tab.

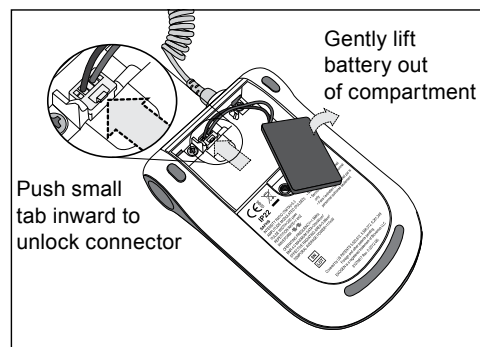

5. Gently lift the battery out of the compartment.
6. Follow the red and black wires to find the battery connector.
7. Push the small tab in and pull up to unlock the battery connector.

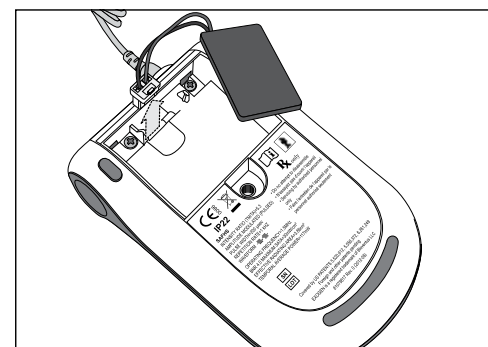

8. Remove and properly dispose of the battery according to your local or national refuse laws.

Troubleshooting

EXOGEN will alert you if something is not working properly. EXOGEN will beep and display an alert screen. See the table below for examples of alerts and what to do if you get an alert.

Alerts	What does this mean?	What should I do?
 Add Gel	<p>Gel Error:</p> <p>The countdown timer stops, EXOGEN beeps and displays the yellow "Add Gel" screen.</p> <p>There is not enough gel on the transducer.</p>	<p>Add more gel to the transducer face opposite the transducer cable exit. See "Add Gel and Place Transducer" on page 8.</p> <p>After you add more gel, place the transducer back over the fracture using the strap or cast port. EXOGEN will stop beeping and the countdown timer will restart. If EXOGEN still beeps and the "Add Gel" screen remains, add more gel.</p>
 Low Battery	<p>Low Battery:</p> <p>You are not able to start treatment or view history. EXOGEN beeps and displays the yellow "Low Battery" screen.</p> <p>The battery level is very low. You must charge EXOGEN.</p>	<p>Plug EXOGEN into a power source with the provided charger. You may charge EXOGEN and treat at the same time.</p> <p>See "Charging EXOGEN" on page 5.</p>
 Contact Customer Service	<p>Contact Customer Service:</p> <p>EXOGEN beeps and displays the yellow "Contact Customer Service" screen.</p> <p>EXOGEN has detected that it is not working properly.</p>	<p>Call Customer Service at 1-855-771-0606. Do not try to fix EXOGEN yourself.</p>
 No Remaining Treatments	<p>No Remaining Treatments:</p> <p>EXOGEN beeps and displays the yellow "No Remaining Treatments" screen.</p> <p>EXOGEN has reached the 343 treatment level or the end of its expected life.</p>	<p>If you are still being instructed by your doctor to treat your fracture with EXOGEN, call Customer Service at 1-855-771-0606 for instructions.</p>

Problems	What does this mean?	What should I do?
Blank screen, EXOGEN does not turn on.	The battery may be completely discharged or the EXOGEN device has malfunctioned.	Plug in charger to EXOGEN and fully charge your battery. If EXOGEN still does not respond, contact Customer Service at 1-855-771-0606 .
The battery area on EXOGEN or the battery charger gets excessively warm.	The battery or charger is malfunctioning.	Stop using EXOGEN and contact Customer Service at 1-855-771-0606 .

Clinical Studies

The EXOGEN Ultrasound Bone Healing System has been evaluated for osseous defect healing in a number of clinical studies¹⁻³⁹. These studies have demonstrated acceleration of fresh fracture by 38% and a nonunion heal rate of 86%.

Metals and Implants

Clinical data indicates that healing rates and acceleration of osseous defect repair is not affected by internal or external metal fixation. Several reference articles have focused on conventional therapeutic ultrasound's effect on surgical metallic, biodegradeable and bioresorbable implants and conclude there are no untoward effects^{13, 40-45}. EXOGEN low intensity pulsed ultrasound is not capable of penetrating metal – when treating osseous defects with plate fixation, place the transducer over the fracture site but not directly over the plate.

Mechanism of Action

Four review articles^{12, 46-48} have assessed the clinical and basic science evidence for the EXOGEN Ultrasound Bone Healing System. Their analyses suggested the EXOGEN Ultrasound Bone Healing System induced cellular reactions at each phase of fracture healing from inflammation through to endochondral ossification and remodelling.

Adverse Events

Unlike conventional (physical therapy) ultrasound devices, EXOGEN is incapable of producing harmful temperature increases in body tissue⁴⁹. The ultrasound output intensity of EXOGEN is 30 mW/cm² and is typically only 1% to 5% of the output intensity of conventional therapeutic ultrasound devices. The ultrasound intensity is comparable to diagnostic ultrasound (1 to 50 mW/cm²), such as the intensities used in obstetrical sonogram procedures (fetal monitoring). In addition, there is no evidence of non-thermal adverse effects (cavitation).

Complications

No device-related adverse reactions or medical complications related to the use of EXOGEN were reported during the clinical studies. Some patients have experienced mild skin irritation caused by skin sensitivity to the coupling gel. If you feel your skin is sensitive to the gel, you may change the coupling medium to mineral oil or glycerin. In the distal radius study, one patient complained of pain during treatment but they no longer had the pain by the next follow up visit; and one patient, complaining of pain, withdrew from the study.

References

- Cook SD, Ryaby JP, McCabe J, Frey JJ, Heckman JD, Kristiansen TK. Acceleration of tibia and distal radius fracture healing in patients who smoke. *Clin Orthop Relat Res*. 1997;337:198-207.
- Coughlin MJ, Smith BW, Traugher P. The evaluation of the healing rate of subtalar arthrodeses, part 2: The effect of low-intensity ultrasound stimulation. *Foot & Ankle International*. 2008;29:970-977.
- Duarte LR. University of Sao Paulo, Brazil, unpublished data presented Societe Internationale de Chirurgie Orthopedique et de Traumatologie (SICOT).
- El-Mowafi H, Mohsen M. The effect of low-intensity pulsed ultrasound on callus maturation in tibial distraction osteogenesis. *Int Orthop*. 2005;29:121-124.
- Frankel VH, Mizuno K. Management of nonunion with pulsed, low-intensity ultrasound therapy-international results. *Surg Technol Int*. 2001;X:1-6.
- Frankel VH. Results of prescription use of pulsed ultrasound therapy in fracture management. *Surg Technol Int*. 1998; VII:389-393.
- Fujioka H, Tanaka J, Yoshiya S, Tsunoda M, Fujita K, Matsui N, Makino T, Kurosaka M. Ultrasound treatment of nonunion of the hook of the hamate in sports activities. *Knee Surg Sports Traumatol Arthrosc*. 2004;12(2):162-164.
- Fujioka H, Tsunoda M, Noda M, Matsui N, Mizuno K. Treatment of ununited fracture of the hook of hamate by low-intensity pulsed ultrasound: a case report. *J Hand Surg*. 2000;25(1):77-79.
- Furue Y. The effect of low-intensity pulsed ultrasound for treatment of nonunion. *Orthopaedic Surgery and Traumatology* (Japanese language). 2000;43(3):231-235.
- Gebauer D, Mayr E, Orthner E, Ryaby JP. Low-intensity pulsed ultrasound: effects on nonunions. *Ultrasound Med Biol*. 2005;31:1391-1402.
- Gold SM, Wasserman R. Preliminary results of tibial bone transports with pulsed low intensity ultrasound (Exogen). *J Orthop Trauma*. 2005;19:10-16.
- Hadjigryou M, McLeod K, Ryaby JP, Rubin C. Enhancement of fracture healing by low intensity ultrasound. *Clin Orthop Relat Res*. 1998;(355S):S216-229.
- Handolin L, Kijunen V, Arnala I, Pajarinen J, Partio EK, Rokkanen P. The effect of low intensity ultrasound and bioabsorbable self-reinforced poly L-lactide screw fixation on bone in lateral malleolar fractures. *Arch Orthop Trauma Surg*. 125(5):317-21.
- Heckman JD, Ryaby JP, McCabe J, Frey JJ, Kilcoyne RF. Acceleration of tibial fracture-healing by non-invasive, low-intensity pulsed ultrasound. *J Bone Joint Surg*. 1994;76-A(1):26-34.
- Jones CP, Coughlin MJ, Shurnas PS. Prospective CT scan evaluation of hindfoot nonunions treated with revision surgery and low-intensity ultrasound stimulation. *Foot & Ankle International*. 2006;27:229-235.
- Katsuki M, Mikami J, Matsuno T. Clinical results of sonic accelerated fracture healing system for upper extremity diseases. *Journal of Japanese Society for Surgery of the Hand*. 2002;19(5):601-605.
- Kristiansen TK, Ryaby JP, McCabe J, Frey JJ, Roe LR. Accelerated healing of distal radial fractures with the use of specific, low-intensity ultrasound. *J Bone Joint Surg*. 1997;79-A(7):961-973.
- Lerner A, Stein H, Soudry M. Compound high-energy limb fractures with delayed union: our experience with adjuvant ultrasound stimulation (Exogen). *Ultrasonics*. 2004;42(1-9): 915-917.
- Leung KS, Lee WS, Tsui HF, Liu PP, Cheung WH. Complex tibial fracture outcomes following treatment with low-intensity pulsed ultrasound. *Ultrasound Med Biol*. 2004;30:389-395.
- Mayr E, Frankel V, Rüter A. Ultrasound-an alternative healing method for nonunions? *Arch Orthop Trauma Surg*. 2000;120:1-8.
- Mayr E, Laule A, Suger G, Rüter A, Claes L. Radiographic results of callus distraction aided by pulsed low-intensity ultrasound. *J Orthop Trauma*. 2001;15(6):407-414.
- Mayr E, Möckl C, Lenich A, Ecker M, Rüter A. Is low intensity ultrasound effective in treating disorders of fracture healing? *Unfallchirurg*. 2002;105:108-115.
- Mayr E, Rudzki MM, Borchardt B, Häusser H, Rüter A. Does pulsed low intensity ultrasound accelerate healing of scaphoid fractures? *Handchir Mikrochir Plast Chir*. 2000;32:115-122.
- Mayr E, Wagner S, Ecker M, Rüter A. Ultrasound therapy for nonunions (pseudarthrosis): three case reports. *Unfallchirurg*. 1999;102(3):191-196.
- Narasaki K. Low intensity ultrasound treatment of nonunion and delayed union cases. *Orthopaedic Surgery and Traumatology* (Japanese language). 2000;43(3):225-230.
- Nolte PA, Klein-Nuland J, Albers GHR, Marti RK, Semeins CM, Goei SW, Burger EH. Low-intensity ultrasound stimulates in vitro endochondral ossification. *J Orthop Res*. 2001;16(2):16-22.
- Nolte PA, van der Krans A, Patka P, Janssen IMC, Ryaby JP, Albers GHR. Low-intensity pulsed ultrasound in the treatment of nonunions. *J Trauma*. 2001;51(4):693-703.
- Pigozzi F, Moneta MR, Giombini A, Giannini S, Di Cesare A, Fagnani F, Mariani PP. Low-intensity pulsed ultrasound in the conservative treatment of pseudoarthrosis. *Journal of Sports Medicine and Physical Fitness*. 2004;44:173-178.
- Pilla AA, Figueiredo M, Nasser PR, Alves JM, Ryaby JT, Klein M, Kaufmann JJ, Siffert RS. *Acceleration of bone-repair by pulsed sine wave ultrasound: animal. Clinical and mechanistic studies. In Electromagnetics in Biology and Medicine*, ed. by CT Brighton and SR Pollock, San Francisco Press. 331-341, 1991.
- Romano C, Messina J, Meani E. Low-intensity ultrasound for the treatment of infected nonunions. In: Agazzi M, Bergami PL, Cicero G, Gualdrini G, Mastorillo G, Meani M, Mintina S, Soranzo ML, editors. *Guarderni di infezione osteoarticolari*. 1999;83-93.
- Sato W, Matsushita T, Nakamura K. Acceleration of increase in bone mineral content by low-intensity ultrasound energy in leg lengthening. *J Ultrasound Med*. 1999;18:699-702.
- Strauss E, Gonya G. Adjunct low intensity ultrasound in charcot neuroarthropathy. *Clin Orthop Relat Res*. 1998;349:132-138.
- Strauss E, Ryaby JP, McCabe JM. Treatment of Jones' fractures of the foot with adjunctive use of low-intensity pulsed ultrasound stimulation. *J Orthop Trauma*. 1999;13(4):310.
- Tsumaki N, Kakiuchi M, Sasaki J, Ochi T, Yoshikawa, H. Low-intensity pulsed ultrasound accelerates maturation of callus in patients treated with opening-wedge high tibial osteotomy by hemicallotaxis. *J Bone Joint Surg Am*. 2004;86-A:2399-2405.
- Uchiyama Y, Nakamura, Y, Mochida J, Tamaki T. Effect of Low-Intensity Pulsed Ultrasound Treatment for Delayed and Nonunion Stress Fractures of the Anterior Mid-Tibia in Five Athletes. *Tokai J Exp Clin Med*. 2007;32:121-125.
- Warden SJ, Bennell KL, McMeeken JM, Wark JD. Acceleration of fresh fracture repair using the sonic accelerated fracture healing system (SAFHS): a review. *Calcif Tissue Int*. 2000;66:157-163.
- Yoshitaka H, Toshiharu S, Osamu U, Toshifumi K, Kazuhisa B. Effect of low internisty ultrasound on severe open fractures. *Seikei Geka* (Orthopaedic Surgery and Traumatology) (Japanese language). 2003;46(1):67-73.
- Emami, A., Petren-Mallmin, M., Larsson, S. No effect of low-intensity ultrasound on healing time of intramedullary fixed tibial fractures. *J Orthop Trauma*. 1999;13:252-257.
- Rue, J.P., Armstrong, D.W., 3rd, Frassica, F.J., Deafenbaugh, M., Wilckens, J.H. The effect of pulsed ultrasound in the treatment of tibial stress fractures. *Orthopedics*. 2004;27:1192-1195.
- Gersten JW. Effect of metallic objects on temperature rises produced in tissue by ultrasound. *Am J Phys Med*. 1988;37:75-82.
- Handolin L, Pohjonen T, Partio EK, Arnala I, Tormala P, Rokkanen P. The effects of low-intensity pulsed ultrasound in bioabsorbable self-reinforced poly L-lactide screw. *Biomaterials*. 2002;23:2733-2736.
- Lehman J, et al. Ultrasonic effects as demonstrated in live pigs with surgical metallic implants. *Arch Phys Med Rehabil*. 1979;483-488.
- Lotsova EI. Effect of ultrasound on the strength of metal fixing pins for fractures and joint injuries. *Mekh Kompoz Mat*. 1979; No. 3, 548-549.

- Premarket Approval P900009/Supplement 6, Summary of safety and effectiveness data: low-intensity pulsed ultrasound device for the noninvasive treatment of nonunions.
- Skoubo-Kristensen E, Sommer J. Ultrasound influence on internal fixation with a rigid plate in dogs. *Arch Phys Med Rehabil*. 1982;63, 371-373.
- Pounder NM, Harrison AJ. Low intensity pulsed ultrasound for fracture healing: A review of the clinical evidence and the associated biological mechanism of action. *Ultrasonics*. 2008;48:330-338.
- Siska PA, Gruen GS, Pape HC. External adjuncts to enhance fracture healing: What is the role of ultrasound? *Injury-International Journal of the Care of the Injured*. 2008;39:1095-1105.
- Rubin C, Bolander M, Ryaby JP, Hadjiargyrou M. The use of low-intensity ultrasound to accelerate the healing of fractures. *J Bone Joint Surg*. 2001;83-A: No. 2, 259,270.
- Ziskin MC. Report on the safety of the Therasonics Medical Systems SAFHS unit, model 2A. PMA900009, vol. 3, section VI.A.1, 209-234.

Technical Information

EXOGEN Operating Specifications

Ultrasound frequency	1.5 +/- 5% MHz
Modulating signal burst width	200+/- 10% microsecond (µs)
Repetition Rate	1.0+/- 10% kilohertz(KHz)
Duty Factor	20%
Effective radiating area (ERA)	3.88 +/- 1% square cm (cm ²)
Temporal average power	117 +/- 30% milliwatts(mW)
Spatial avg.-temporal avg. (SATA)	30+/- 30% mW/cm ²
Beam non-uniformity ratio (BNR)	4.0 maximum
Battery	3.7 VDC, 700 mAh
Battery Type	Lithium-ion
Input Voltage (USB)	5.0 VDC, 2.6A max.
Beam type	Collimated

The essential performance of EXOGEN includes the following:

- Free from the display of incorrect numerical values (numbers) associated with the ultrasound therapy
- Free from the production of unwanted ultrasound output
- Free from the production of excessive ultrasound output
- Free from the production of unintended or excessive transducer surface temperature

EXOGEN Classifications

EXOGEN has the following classifications:

- Internally Powered Equipment
- Type BF Applied Part
- EXOGEN device: IP-22 protection against ingress of water
- Transducer: IP-67 protection against ingress of dust
- Equipment not suitable for use in the presence of a flammable anaesthetic mixture with air or with oxygen or with nitrous oxide.
- Mode of operation – Intermittent

Guidance and Manufacturer's Declaration – Electromagnetic Emissions and Immunity Testing

Electromagnetic Compatibility Testing

Summary: *Testing Report for:*
Bioventus LLC.

Equipment Under Test: EXOGEN®

Used for Life Support: No

Use in shielded enclosure: No

Guidance and manufacturer's declaration – electromagnetic emissions		
EXOGEN is intended for use in the electromagnetic environment specified below. The customer or the user of EXOGEN should assure that it is used in such an environment.		
Emissions Test	Compliance	Electromagnetic environment – guidance
RF emissions CISPR 11	Group 1	EXOGEN uses RF energy only for its internal function. Therefore, its RF emissions are very low and are not likely to cause any interference in nearby electronic equipment.
RF emissions CISPR 11	Class B	EXOGEN is suitable for use in all establishments, including domestic and those directly connected to the public low-voltage power supply network that supplies buildings used for domestic purposes.
Harmonic emissions IEC 61000-3-2	Class A	
Voltage fluctuations / flicker emissions IEC 61000-3-3	Complies	

Guidance and manufacturer's declaration – electromagnetic immunity

EXOGEN is intended for use in the electromagnetic environment specified below. The customer or the user of the EXOGEN should assure that it is used in such an environment.

Immunity test	IEC 60601 Test Level	Compliance Level	Electromagnetic environment - guidance
Electrostatic discharge (ESD) IEC 61000-4-2	±6 kV contact ±8 kV air	±6 kV contact ±8 kV air	Floors should be wood, concrete or ceramic tile. If floors are covered with synthetic material, the relative humidity should be at least 30%.
Electrical fast transient/burst IEC 61000-4-4	±2 kV for power supply lines ±1 kV for input/output lines	±2 kV for power supply lines Not Applicable for input/output lines	Mains power quality should be that of a typical commercial or hospital environment.
Surge IEC 61000-4-5	±1 kV differential mode ±2 kV common mode	±1 kV differential mode ±2 kV common mode	Mains power quality should be that of a typical commercial or hospital environment.
Voltage dips, short interruptions and voltage variations on power supply input lines IEC 61000-4-11	<5% U_T (>95% dip in U_T) for 0,5 cycle; 40% U_T (60% dip in U_T) for 5 cycles; 70% U_T (30% dip in U_T) for 25 cycles; <5% U_T (>95 % dip in U_T) for 5 sec	<5% U_T (>95% dip in U_T) for 0,5 cycle; 40% U_T (60% dip in U_T) for 5 cycles; 70% U_T (30% dip in U_T) for 25 cycles; <5% U_T (>95 % dip in U_T) for 5 sec	Mains power quality should be that of a typical commercial or hospital environment. If the user of EXOGEN requires continued operation during power mains interruptions, it is recommended that EXOGEN be powered from an uninterruptible power supply or a battery.
Power frequency (50/60 Hz) magnetic field IEC 61000-4-8	3 A / m	3 A / m	Power frequency magnetic fields should be at levels characteristic of a typical location in a typical commercial or hospital environment.
Conducted RF IEC 61000-4-6 Radiated RF IEC 61000-4-3	3 Vrms 150 kHz to 80 MHz 3 V/m 80 MHz to 2,5 GHz	3 Vrms 3 V/m	Portable and mobile RF communications equipment should be used no closer to any part of EXOGEN, including cables, than the recommended separation distance calculated from the equation applicable to the frequency of the transmitter. Recommended separation distance: $d = 1.2 \sqrt{P}$ $d = 1.2 \sqrt{P}$ 80 MHz to 800 MHz $d = 2.3 \sqrt{P}$ 800 MHz to 2,5 GHz where P is the maximum output power rating of the transmitter in watts (W) according to the transmitter manufacturer and d is the recommended separation distance in meters (m). Field strengths from fixed RF transmitters, as determined by an electromagnetic site survey, ¹ should be less than the compliance level in each frequency range. ² Interference may occur in the vicinity of equipment marked with the following symbol: 

NOTE U_T is the a.c. mains voltage prior to application of the test level.

NOTE 1 At 80 MHz and 800 MHz, the higher frequency range applies.

NOTE 2 These guidelines may not apply in all situations. Electromagnetic propagation is affected by absorption and reflection from structures, objects and people.

¹Field strengths from fixed transmitters, such as base stations for radio (cellular/cordless) telephones and land mobile radios, amateur radio, AM and FM radio broadcast and TV broadcast cannot be predicted theoretically with accuracy. To assess the electromagnetic environment due to fixed RF transmitters, an electromagnetic site survey should be considered. If the measured field strength in the location in which EXOGEN is used exceeds the applicable RF compliance level above, EXOGEN should be observed to verify normal operation. If abnormal performance is observed, additional measures may be necessary, such as re-orienting or relocating EXOGEN.

²Over the frequency range 150 kHz to 80 MHz, field strengths should be less than 1 V/m.

Recommended separation distances between portable and mobile RF communications equipment and EXOGEN

EXOGEN is intended for use in an electromagnetic environment in which radiated RF disturbances are controlled. The customer or the user of EXOGEN can help prevent electromagnetic interference by maintaining a minimum distance between portable and mobile RF communications equipment (transmitters) and EXOGEN as recommended below, according to the maximum output power of the communications equipment.

Rated maximum output power of transmitter – watts (W)	Separation distance according to frequency of transmitter – meter (m)		
	150 kHz to 80 MHz $d = 1.2 \sqrt{P}$	80 MHz to 800 MHz $d = 1.2 \sqrt{P}$	800 MHz to 2,5 GHz $d = 2.3 \sqrt{P}$
0.01	0.12	0.12	0.23
0.1	0.38	0.38	0.73
1	1.2	1.2	2.30
10	3.79	3.79	7.27
100	12.00	12.00	23.00

For transmitters rated at a maximum output power not listed above, the recommended separation distance d in meters (m) can be estimated using the equation applicable to the frequency of the transmitter, where P is the maximum output power rating of the transmitter in watts (W) according to the transmitter manufacturer.

NOTE 1 At 80 MHz and 800 MHz, the separation distance for the higher frequency range applies.

NOTE 2 These guidelines may not apply in all situations. Electromagnetic propagation is affected by absorption and reflection from structures, objects and people.

Test Report # 100972305ATL-002, 02/07/2013. Testing performed by: Intertek, 1950 Evergreen Blvd, Suite 100, Duluth, GA 30096.

Customer Service

Customer Service is available to answer questions regarding EXOGEN and to handle disposal needs.

To contact the Service Centre:

Call: 1-855-771-0606



Authorized European Community (EC) Representative

EMERGO EUROPE

Prinsessegracht 20
2514 AP The Hague
The Netherlands

Tel: +31 (0) 70 345-8570
Fax: +31 (0) 70 346-7299

For additional information on the EXOGEN
Ultrasound Bone Healing System, please visit our
website at www.exogen.com.

Limited Warranty

Bioventus LLC ("Seller") warrants to the original purchaser ("Purchaser") of its EXOGEN Ultra-sound Bone Healing System ("System") purchased by Purchaser directly from Seller that the System conforms to Seller's manufacturing specifications. This warranty shall be in effect for a period of one year from the date of purchase.

In the event of a material breach of this warranty, upon timely written notice, Seller will, at its sole option, either repair or replace the System or refund the original purchase price. This will constitute Purchaser's sole remedy. This limited warranty does not extend to any re-sale or other transfer of the System by Purchaser to any other person or entity.

Seller expressly disclaims any and all other warranties, either expressed or implied, relating to the System or its performance, including, without limitation, any IMPLIED WARRANTY OF MERCHANTABILITY and any IMPLIED WARRANTY OF FITNESS FOR A PARTICULAR PURPOSE.



Authorized European Community (EC)

Representative

EMERGO EUROPE
Prinsessegracht 20
2514 AP The Hague
The Netherlands

Tel: +31 (0) 70 345-8570

Fax: +31 (0) 70 346-7299



Bioventus LLC

4721 Emperor Blvd Suite 100
Durham, NC 27703 USA

Customer Service: **1-855-771-0606**

www.exogen.com

© 2017 Bioventus LLC All rights reserved
Bioventus, the Bioventus logo and EXOGEN
are registered trademarks of Bioventus LLC.

Product No. 81087031 Rev. B
2017-09

