











# EXOGEN<sup>®</sup> User Guide

Read before using your device



# EXOGEN Label Symbol Descriptions and Equipment Classification

	Information Symbol: refer to User Guide.
	Catalog Number
	Type BF Applied Part. The transducer, shown in Figure 2 on page 2 is an applied part.
	EU: Not for General Waste. This symbol indicates that EXOGEN should not be disposed of with ordinary household waste at the end of its life. For details on how to dispose of this device correctly, contact your local government waste disposal agency or your local Bioventus representative.
	Manufacturer
	Serial number (first four digits of the serial number indicate the month and year of manufacture)
WAVEFORM 	Pulsed Signal
	Rx Symbol: Federal Law (U.S.A.) restricts this device to sale, distribution, or use by or on the order of a physician or properly licensed practitioner. This device is only intended for use by the individual for whom it is prescribed.
	Caution symbol: Indicates the need for the user to consult the instructions for use for important cautionary information.
	Indicates the item is a medical device.
	Indicates the device may be used multiple times on a single patient.

## Caution

Federal Law (U.S.A.) restricts this device to sale, distribution, or use by or on the order of a physician or properly licensed practitioner. EXOGEN is only intended for use by the individual for whom it is prescribed. EXOGEN is for single patient use ONLY.

THIS DEVICE IS NON-STERILE.  
It does not require sterilization before use.

# Table of Contents

<b>EXOGEN Overview</b>	<b>1</b>	<b>EXOGEN Care</b>	<b>17</b>
Indications for Use	1	Operating Conditions	17
EXOGEN Description	1	Storage	17
EXOGEN Device (EXOGEN)	2	EXOGEN Expected Service Life	17
Charger (power supply)	2	Battery and Charging Safety	18
Strap	2	EXOGEN Disposal	19
Ultrasound Gel	3	Removing the Battery for Disposal	19
Important Things to Know	3		
EXOGEN Usage	3	<b>Troubleshooting</b>	<b>20</b>
Contraindications	3	<b>Clinical Studies</b>	<b>21</b>
Warnings	3	<b>Adverse Events</b>	<b>24</b>
Precautions	4	<b>Complications</b>	<b>24</b>
Display Symbols and Descriptions	4	<b>References</b>	<b>26</b>
		<b>Technical Information</b>	<b>27</b>
<b>Getting Started</b>	<b>5</b>	<b>EXOGEN Classifications</b>	<b>28</b>
Charging EXOGEN	5	<b>Guidance and</b>	
Recharging EXOGEN	6	<b>Manufacturer's Declaration</b>	<b>29</b>
Preparing to Treat Your Fracture	7	<b>Customer Service</b>	<b>32</b>
Place the Strap	7	Limited Warranty	32
If You Have a Cast	8		
Add Gel and Place Transducer	8		
<b>First Use – EXOGEN Setup</b>	<b>9</b>		
First Use	9		
Hour Setting	9		
Treating Your Fracture	10		
Start Treatment	10		
EXOGEN Cleaning	11		
<b>Tracking Your Treatment</b>	<b>13</b>		
Track Usage	13		
Treatment Calendar	13		
Treatment Summary Data	14		
Treatment History	15		
Calendar Pause	16		

# EXOGEN Overview

## Indications for Use

The EXOGEN Ultrasound Bone Healing System is indicated for:

- The non-invasive treatment of established non-unions<sup>1</sup> excluding skull and vertebra
- The EXOGEN device has also been reported as effective as an adjunctive non-invasive treatment of established non-unions in patients:
  - With internal or external fracture fixation hardware present. EXOGEN cannot penetrate metal and therefore should not be applied directly over hardware.
  - Undergoing treatment for infection at the fracture site. EXOGEN is not intended to treat the infection.
  - Believed to have diminished bone quality. EXOGEN is not intended to treat diminished bone quality.
- Accelerating the time to a healed fracture for fresh, closed, posteriorly displaced distal radius fractures (fractures of the end of the large bone in your forearm) and fresh, closed or Grade I open tibial diaphysis fractures (fractures in the middle 80% of the large bone in your lower leg) in skeletally mature individuals when these fractures are orthopaedically managed by closed reduction and cast immobilization (adult individuals eighteen years of age or older who have fractures, with or without minor skin wounds, that are placed in a cast for treatment).

<sup>1</sup>A non-union is considered to be established when the fracture site shows no visibly progressive signs of healing.

## EXOGEN Description

The EXOGEN Ultrasound Bone Healing System provides non-invasive therapy for healing non-unions and accelerating time to healing of fresh fractures. EXOGEN is designed both for use with conservatively-treated fresh fractures and non-unions, or surgically-treated non-unions. EXOGEN transmits a low-intensity ultrasound signal to the fracture site through coupling gel, with little or no sensation felt by the patient during the treatment. Low-intensity pulsed ultrasound has been shown in in-vitro and in-vivo studies to stimulate cells to produce growth factors and proteins that are important to bone healing.

The patient administers treatment at home or at work, once daily, for 20 minutes, or as prescribed by a physician. EXOGEN automatically alerts the patient in case of improper application or performance. The EXOGEN Ultrasound Bone Healing System consists of one EXOGEN device, a charger, a gel bottle and strap. The EXOGEN device provides the treatment control circuitry, the battery supply and monitors the operation of the transducer at the fracture site. The signal specifications cannot be changed.

Everything you need to treat your fracture is included in the EXOGEN Ultrasound Bone Healing System. (See **Figure 1**). If one of the items in **Figure 1** is missing, please contact Customer Service at **1-800-836-4080** to receive a replacement.

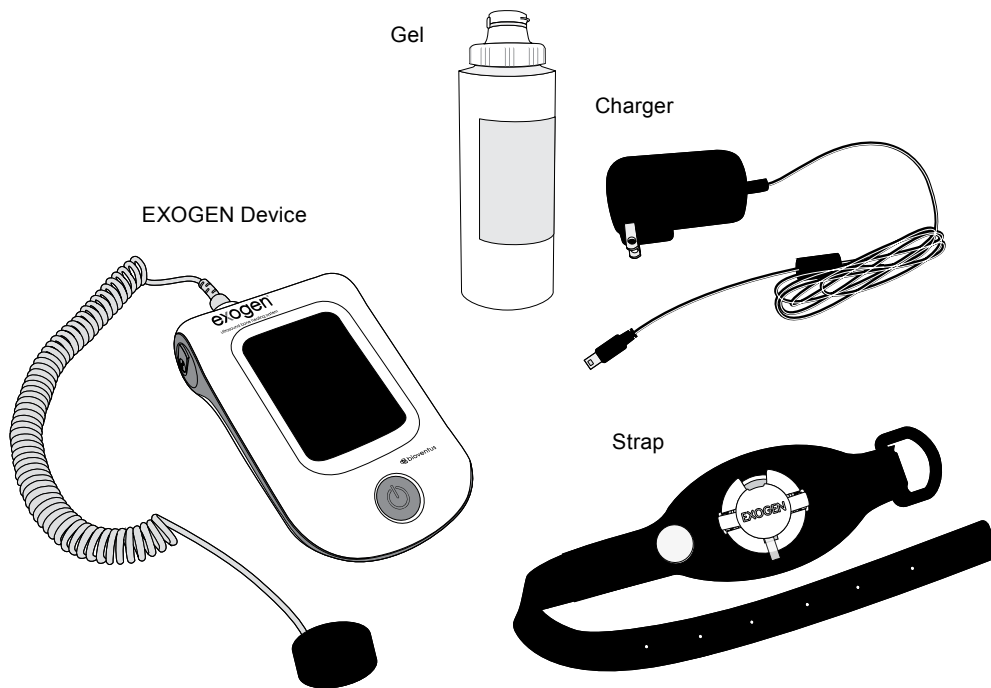

**Figure 1:** EXOGEN Ultrasound Bone Healing System

## EXOGEN Device (EXOGEN)

EXOGEN (**Figure 2**) features a transducer at the end of a coiled cord, color screen, power button and USB charging port. The cord and transducer are not removable from EXOGEN.

EXOGEN contains the internal electronics and battery. It checks the ultrasound signal to make sure EXOGEN works properly. The transducer sends low-intensity pulsed ultrasound to the fracture site through the gel. EXOGEN can also sense if gel is present on the transducer surface.

EXOGEN stores and displays a calendar of daily use. This data is available to you and your physician.

EXOGEN has a mini-USB charging port to allow you to recharge the battery. EXOGEN will not communicate with any other electrical devices.

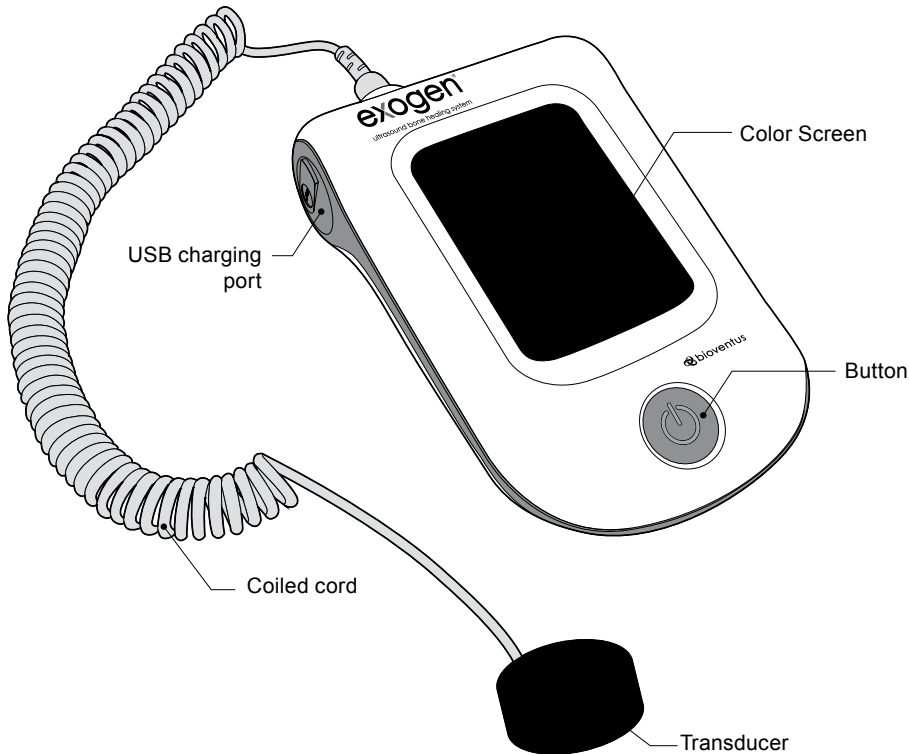

**Figure 2** – EXOGEN Device

## Charger (power supply)

EXOGEN is powered by a rechargeable battery. A charger (**Figure 3**) is included with EXOGEN. Only use this supplied charger with EXOGEN. Do not plug other chargers into EXOGEN. Other chargers may cause injury to you or others near EXOGEN as well as damage to the charger. The use of chargers, transducers or cables, other than those supplied, may result in increased radio frequency emissions or decreased electromagnetic immunity of the EXOGEN which may cause EXOGEN to stop working.

The USB plug end of the cord plugs into EXOGEN. The other end plugs into a wall outlet. The charger requires a standard US 120 VAC, 60 Hz, household electrical outlet.

Read more about how to charge EXOGEN in “Getting Started” on page 5.

**Figure 3** – EXOGEN Charger

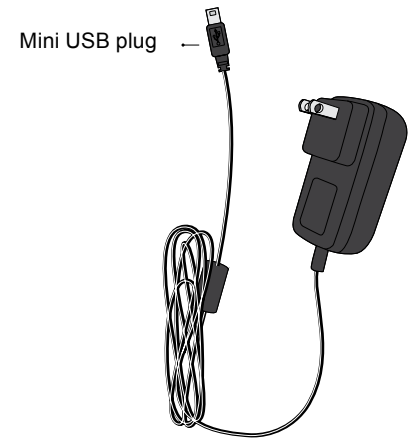

## Strap

The strap (**Figure 4**) is used to position the transducer over your treatment site. The strap has a port in it to hold the transducer in place. The cap holds the transducer down on the treatment site. The strap is adjustable to fit most fracture locations. If your strap does not fit the location of your fracture, please contact Customer Service at **1-800-836-4080** to find out if there is another strap which may fit better.

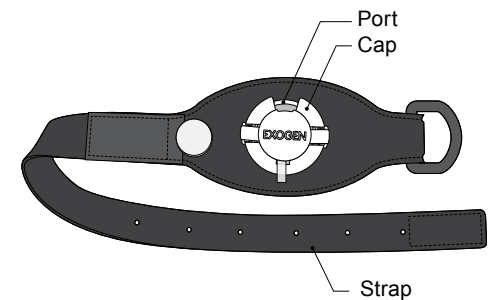

**Figure 4** – EXOGEN Strap

## Ultrasound Gel

Ultrasound gel (**Figure 5**) is provided for use with EXOGEN. The gel is to be placed on the transducer every time you use EXOGEN. The gel lets the ultrasound signal reach your fracture through your skin. EXOGEN will not work properly if gel is not covering the transducer and you will receive an alert from EXOGEN.

Only use the gel supplied. Do not use other gels as they may damage the transducer surface or block the signal. If you need more gel, please call Customer Service at **1-800-836-4080**.

The expiration date for the ultrasound gel is located on the side of the gel bottle.

**Note:** Some patients have experienced mild skin irritation caused by skin sensitivity to the gel. If you feel your skin is sensitive to the gel, you may change the gel to mineral oil lubricant for skin or glycerin.

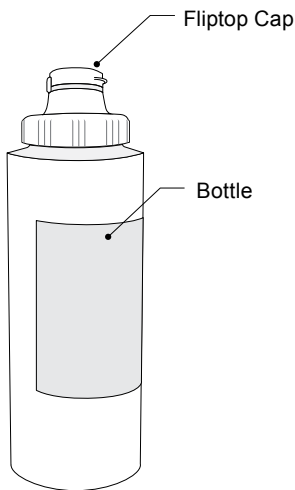

**Figure 5** – Ultrasound Gel

## Important Things to Know

EXOGEN is approved for use by persons that are 18 years or older and skeletally mature. There is no maximum age limit to using EXOGEN. The anticipated education level of an EXOGEN user is to read English at an 8th Grade level or equivalent, and the ability to read and understand Western Arabic numerals. No special previous experience or skills are needed or expected to be able to operate EXOGEN. There may be physical impairments that result from the presence of a fracture, such as reduced range of motion or immobility. EXOGEN is expected to be used with one hand for guiding and holding EXOGEN.

Read “Getting Started” (page 5) and “Treating Your Fracture” (page 10) before you begin using EXOGEN.

## EXOGEN Usage

EXOGEN should be used for 20 minutes per day or as prescribed by your doctor. It is important that you use EXOGEN as prescribed by your doctor to get the full benefit of the treatment. Your doctor will decide when your fracture is healed. Every fracture is different and it takes some fractures longer to heal than others. Call your doctor if you have questions or concerns about your fracture.

EXOGEN is for single patient use only. EXOGEN will deliver 343 full 20-minute treatments. If this number is reached and you are still treating your fracture under your doctor’s direction, contact Customer Service at **1-800-836-4080** for instructions.

## Contraindications

There are no known contraindications to the use of EXOGEN.

## Warnings

The safety and effectiveness of the use of EXOGEN has not been established for:











- Fractures with post-reduction displacement of more than 50% (i.e., fractures in which the opposing broken bone ends are out of alignment by more than one half of the width of the bone)
- Pathological fractures due to bone pathology or malignancy (fractures due to disease)
- Pregnant or nursing women
- Individuals with thrombophlebitis (blood clot in a vein), vascular insufficiency (poor blood supply), abnormal skin sensitivity (very sensitive skin), sensory paralysis (lack of sensation), alcoholism and/or nutritional deficiency
- Individuals receiving steroid, anticoagulant, prescription non-steroidal anti-inflammatory, calcium channel blocker and/or diphosphonate therapy. Individuals using these therapies were excluded from the studies because of the possible effects of these therapies on bone metabolism
- Non-unions of the vertebra and the skull
- Individuals lacking skeletal maturity
- Fresh fracture locations other than the distal radius (end of the large bone in the forearm) or tibial diaphysis (middle 80% of the large bone in your lower leg)
- Fresh fractures that are open Grade II or III (fractures with large wounds) or that require surgical intervention with internal or external fixation (screws and/or plates used to hold your broken bones in place) or that are not sufficiently stable for closed reduction (manipulation of the fracture without surgery) and cast immobilization (cast treatment)

## Precautions

- EXOGEN will not correct or alter post-reduction (when your fracture is initially set and placed in a cast) aspects of a fracture such as displacement, angulation or malalignment
- The transducer, strap and gel are not sterile and placement on an open wound is not advised
- The operation of active, implantable devices, such as cardiac pacemakers may be adversely affected by close exposure to EXOGEN. The physician should advise the patient or other person in close proximity during treatment to be evaluated by the attending cardiologist or physician before starting treatment with EXOGEN
- The cords pose a risk for strangulation. Keep out of reach of children

- Cell phones, televisions, and other devices using radio frequency energy may cause interference. This interference may cause EXOGEN to operate improperly or stop operating completely. While EXOGEN complies with the limits for Class B digital devices pursuant to Part 15 of the FCC rules, it has not been studied with all brands and models of phone
- The safety and effectiveness of EXOGEN when used for more than one daily 20-minute treatment period has not been studied. Patients in the clinical studies were instructed to apply EXOGEN for one treatment period of twenty-minutes each day
  - The age ranges of the patients in the PMA non-union studies were 17-86. The effect of EXOGEN therapy on patients outside this age range has not been studied
  - The age ranges of the patients in the PMA fresh fracture studies were 17-67. The effect of EXOGEN therapy on patients outside this age range has not been studied
- The safety and effectiveness of the use of EXOGEN has been demonstrated for patients followed up over a period of 6.5 years (78 months)
- When choosing a treatment site ensure that the site selected allows for full contact of the transducer face with the skin. Failure to do so may result in the transducer being only partially coupled to the skin. This may reduce the effectiveness of EXOGEN in treating the fracture.
- Placement of the transducer directly over internal fixation may result in the treatment signal being partially or fully blocked and may reduce the effectiveness of EXOGEN in treating the fracture.
- When choosing a treatment site, the transducer shall be positioned such that the ultrasound beam is not impeded by any internal fixation which is directly in line with the fracture site (e.g., not directly over metal plating). This may require placement of the transducer on the opposite side of the limb or perpendicular to the fracture line. Correct placement should be confirmed using radiographic and/or anatomical markers by a healthcare provider during the fitting of the device. The site of application should be marked onto the patient's skin with an indelible marker to guide repeatable placement.

## Display Symbols and Descriptions

Symbol	Name	Description
	<b>Charging Symbol</b>	Flashes to show EXOGEN is plugged in and charging.
	<b>Battery Status</b>	Shows how much charge is left in the battery.
	<b>Calendar X-Mark</b>	A 20-minute treatment was not completed on this calendar day.
	<b>Calendar Checkmark</b>	A 20-minute treatment was completed on this calendar day.
	<b>Calendar Double Checkmark*</b>	Two-20 minute treatments were completed on this calendar day.
	<b>Calendar Double Checkmark Plus*</b>	Three or more 20-minute treatments were completed on this calendar day.
	<b>Treatment Day</b>	Day in which at least one full treatment was delivered
	<b>Missed Treatment Day</b>	Day in which zero full treatments were delivered
<b>20:00</b>	<b>Countdown Timer</b>	Counts down from 20 minutes to show treatment time remaining.
	<b>Treatment Day Streak</b>	Consecutive treatment days in which at least one full treatment was delivered.
 <b>Treatment Complete</b>	<b>Treatment Complete</b>	Automatically displays when countdown timer reaches zero to show that treatment is complete.

\*EXOGEN should be used for only 20 minutes per day, or as prescribed by your doctor.

# Getting Started

## Charging EXOGEN

EXOGEN has a rechargeable lithium-ion battery. A fully-charged battery delivers approximately five 20-minute treatments. It takes about 5 hours to fully charge a discharged EXOGEN battery.

**WARNING:** To avoid the risk of electric shock, EXOGEN must only be connected to a supply mains with protective earth (a 3-prong electrical outlet). Do not use any adapters or extension cords to charge EXOGEN. Only plug the charger into an UL listed electrical outlet.

**Charge EXOGEN** before you begin a treatment or turn EXOGEN on. Follow the steps below to charge EXOGEN:

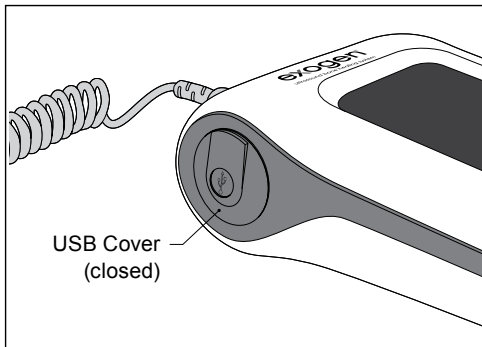

1. Find the USB cover on the left side of EXOGEN.

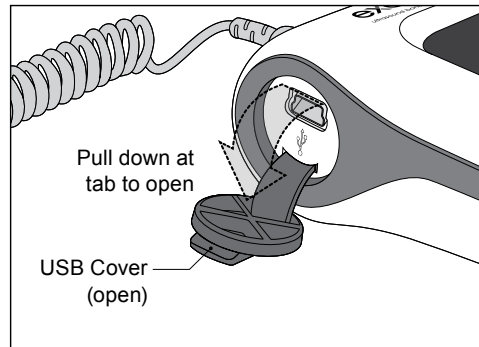

2. Pull the tab down to open the USB cover.

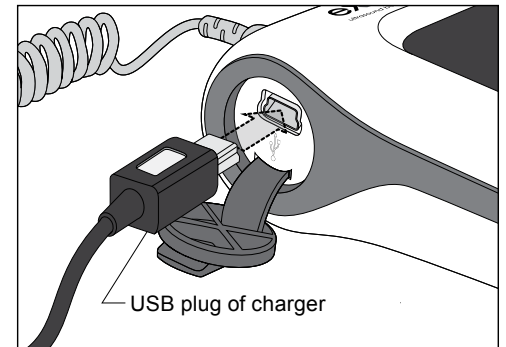

3. Plug the end of the charger into an electrical outlet. Plug the USB plug end of the charger into the USB port.

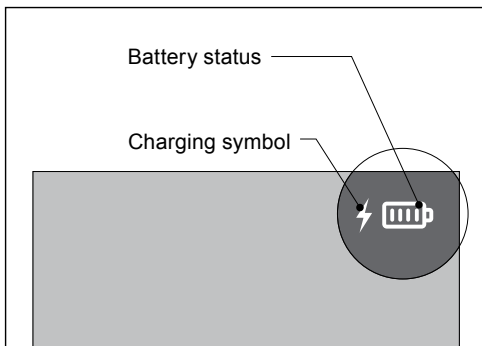

4. You will see the charging symbol (white lightning bolt) and battery status symbol flashing in the corner of the screen. This lightning bolt charging symbol tells you EXOGEN is charging. Charge EXOGEN until a fully-charged battery is shown by the battery status. (**Figure 6**)

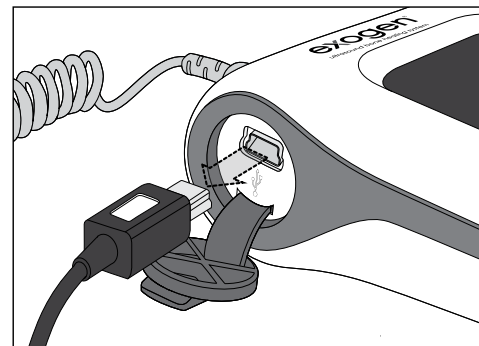

5. When charging is complete, remove the USB plug from EXOGEN, close the USB cover and unplug the charger from the wall.



As you use EXOGEN, the symbol will change to show the reduced battery level. See **Figure 6**.

#### Battery Charge Levels



Full Charge



Partial Charge



Partial Charge



Low Charge

**Figure 6** – Battery Status Symbols

You may charge EXOGEN at any time, whether it is on or off. When the battery level is low, you must charge EXOGEN before your next treatment.

You can charge EXOGEN and treat your fracture at the same time. Use the charger provided in the EXOGEN Ultrasound Bone Healing System.

Do not connect EXOGEN to any other electrical equipment. EXOGEN is unable to communicate with any other electrical equipment.

#### **BATTERY PROBLEM?**

Try fully charging EXOGEN with the charger provided. If your EXOGEN unit still does not work, call Customer Service at **1-800-836-4080**. Do not try to fix EXOGEN yourself.

#### **Recharging EXOGEN**

Check the charge level on EXOGEN following treatment. If the battery is low, charge EXOGEN with the supplied charger. See “Charging EXOGEN” (page 5) for instruction on charging EXOGEN.

## Preparing to Treat Your Fracture

To treat your fracture, you will need EXOGEN, the gel and strap. If you have a cast around your fracture, you will not need the strap.

Your doctor may have marked your fracture site with an 'X', or told you where to treat your fracture. This is the spot to place the transducer to treat your fracture. Contact your doctor if you are not sure where to treat your fracture.

Before you begin, check the cable and the transducer for any cracks or signs of damage. If damaged, do not use EXOGEN and contact Customer Service at **1-800-836-4080**.

**Precaution:** The transducer, strap and gel are not sterile and placement on an open wound is not advised.

**If you have a cast, proceed to "If You Have a Cast" (page 8).**

## Place the Strap

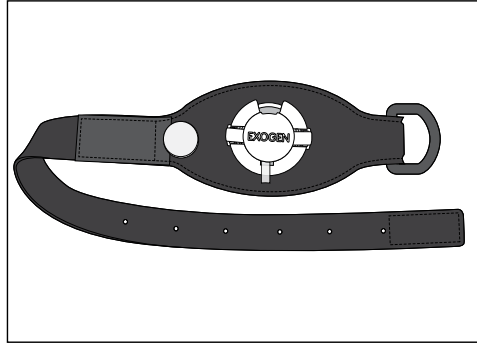

1. Position the strap with the cap facing up.

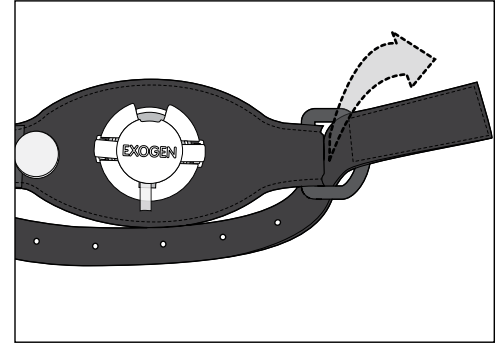

2. Pull the long end of the strap through the plastic loop, as shown.

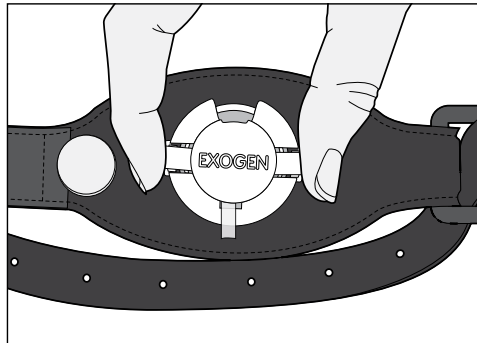

3. Use 2 fingers to squeeze the cap tabs together to open the cap.

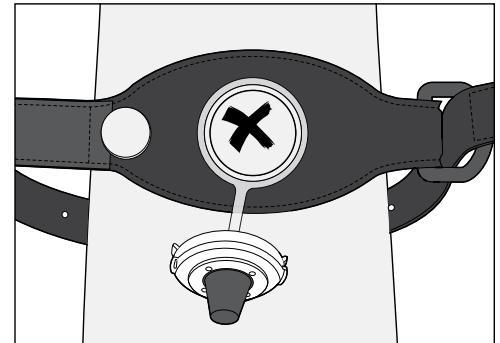

4. Slide on the strap and place the port over the 'X' mark on your skin.

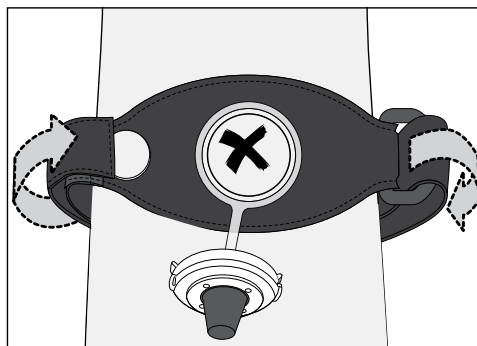

5. Tighten the strap by pulling on the long end. Fasten the strap in place. Do not make the strap too tight!

» Continue to "Add Gel and Place Transducer"

## If You Have a Cast

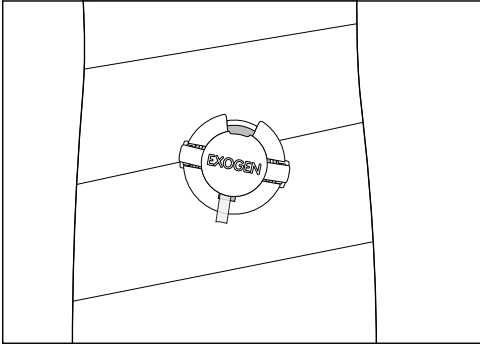

1. Your cast will have a plastic port with cap built into it.

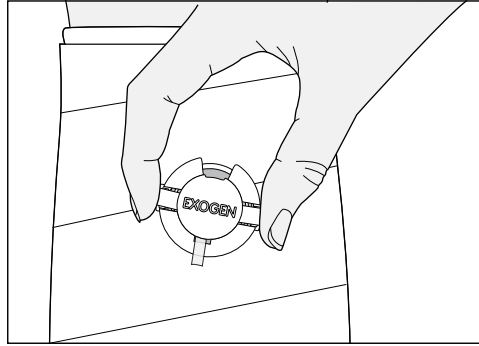

2. Use 2 fingers to squeeze the cap tabs together to open the cap.

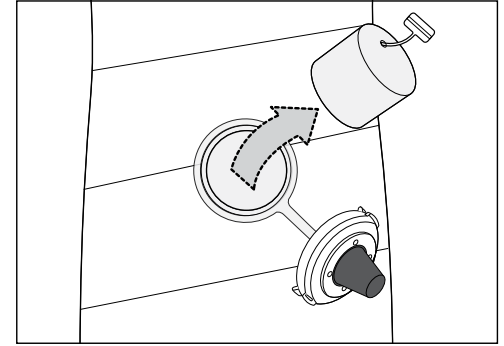

3. Pull out the round felt plug inside the opening.

## Add Gel and Place Transducer

**Note:** Some patients have experienced mild skin irritation caused by skin sensitivity to the gel. If you feel your skin is sensitive to the gel, you may change the gel to mineral oil lubricant for skin or glycerin.

Add gel on the transducer every time you treat your fracture.

1. Open the cap on the gel bottle.
2. Hold the transducer so the cord is down and the smooth side of the transducer is up.

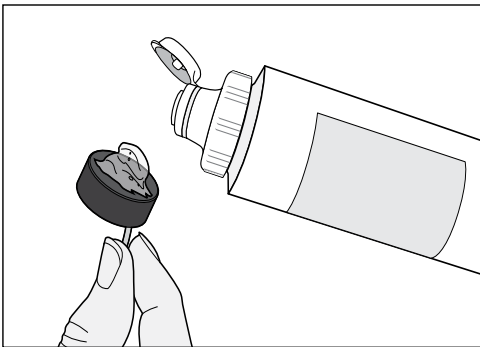

3. Apply a dime size amount of ultrasound gel on the smooth side of the transducer. Spread the gel over the entire face of the transducer.

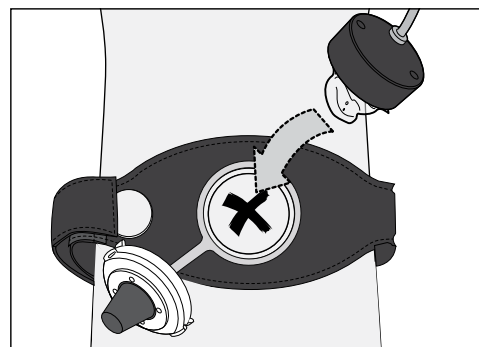

4. Put the transducer, gel side down, into the port. The gel will be touching the skin over your treatment site.

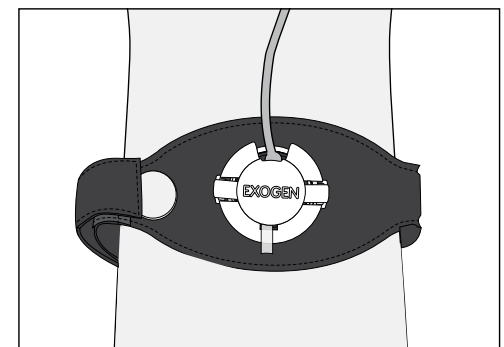

5. Align the cord coming out of the transducer with the notch in the cap. Snap the cap shut on the strap or the cast.
6. Replace the cap on the gel bottle.

» Continue to "First Use"  
or "Start Treatment"

# EXOGEN Setup

## First Use

EXOGEN has a calendar which tracks how often the system is used. The current hour needs to be set to make sure the calendar is accurate.

The hour must be set once, the very first time EXOGEN is turned on.

### Hour Setting

1. Press the button once. The hour and AM/ PM show on the screen. This may or may not be your current hour. The clock must be set to your current hour. For example, if your time is anywhere between 2:00 PM and 2:59 PM, set the hour to 2 PM.

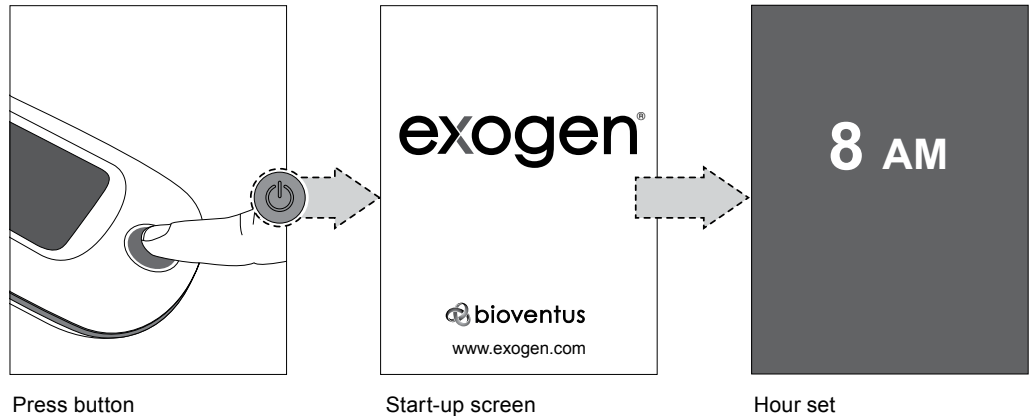

2. Press the button once to advance the time one hour. Press the button, one press at a time, until the correct hour and AM/PM is displayed on the screen.

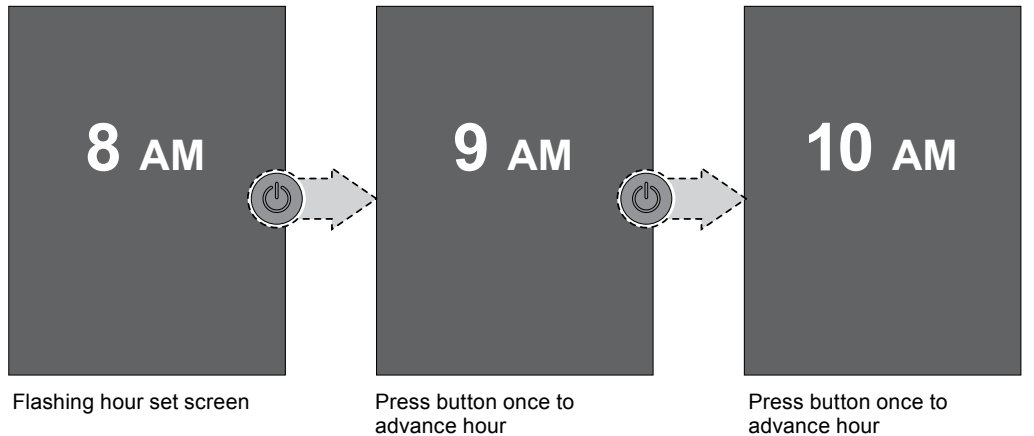

3. **Press and hold** button until you see the hour confirmation screen. This indicates that the hour has been set on EXOGEN. You do not need to set the minutes. After 5 seconds the device will automatically turn off.

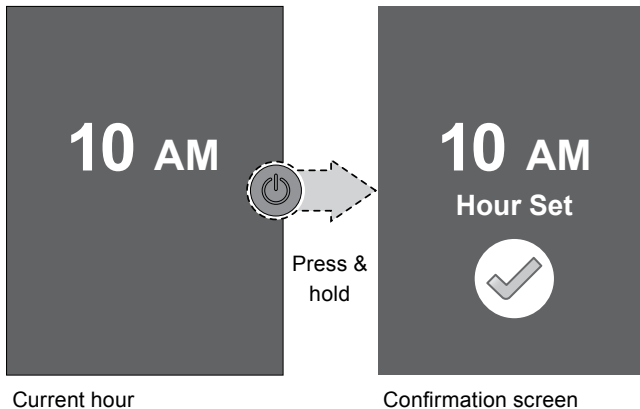

Contact Customer Service at **1-800-836-4080** if you have incorrectly set the hour and would like to reset it.

**Note:** EXOGEN will effectively deliver treatment even if the correct hour is not selected.

# Treating Your Fracture

## Start Treatment

Hold EXOGEN in your hand to view the screen, or set EXOGEN down on a nearby flat surface. Perform the following steps to begin treatment:

1. Press the button on EXOGEN. EXOGEN beeps and the start-up screen appears for 2 seconds.
2. A calendar appears on the screen for 5 seconds. It shows the current month and your treatment summary. For more information on the calendar screen, see "Tracking Your Treatment" on page 13.
3. Next, the 20-minute countdown timer appears on the screen. EXOGEN automatically begins the ultrasound treatment. Above the countdown timer, a dot next to an orange progress bar flashes as the timer counts down. This means you are treating your fracture. The device displays usage summary information throughout the treatment. The usage summary information is detailed in the Usage Summary Information section on page 14. (Note: To stop EXOGEN in the middle of the 20-minute treatment, press and hold the button until EXOGEN turns off.) If your EXOGEN has an error during treatment, see "Troubleshooting" on page 20.
4. When the countdown timer reaches zero, EXOGEN beeps and shows the treatment complete checkmark. The treatment complete checkmark displays for 5 seconds. Then, the calendar appears on the screen for 5 seconds displaying the completed treatment and updated treatment summary information. Finally, the device will automatically turn off.

**Warning:** Use of this equipment adjacent to or stacked with other equipment should be avoided because it could result in improper operation. If such use is necessary, this equipment and the other equipment should be observed to verify that they are operating normally.

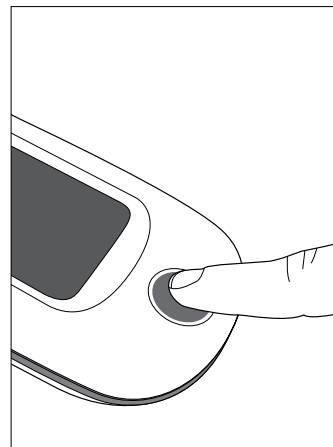

Press button

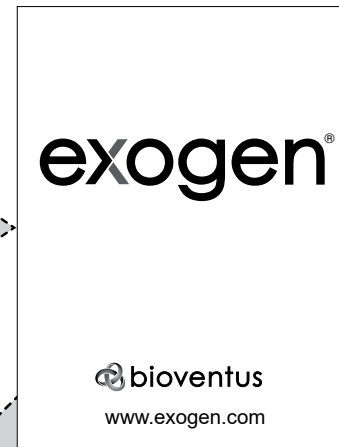

Start-up screen



Calendar

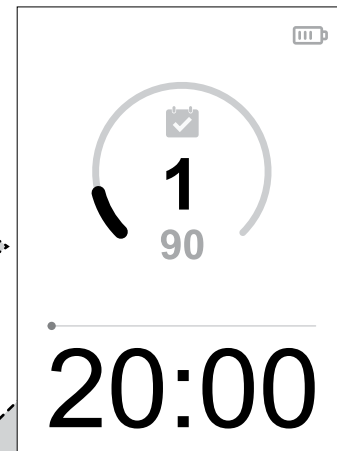

Treatment countdown

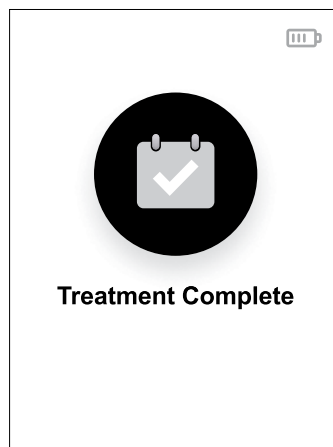

Completion



Updated Calendar

## EXOGEN Cleaning

After treatment is complete, you must clean the transducer after each use.

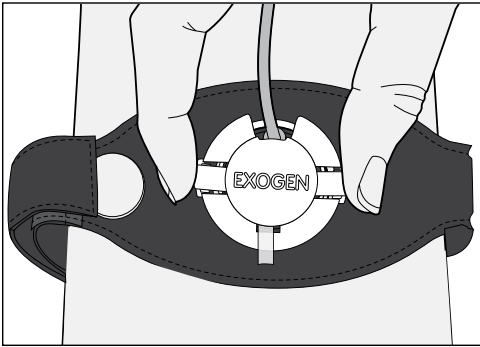

1. Squeeze tabs to open the cap on the port.

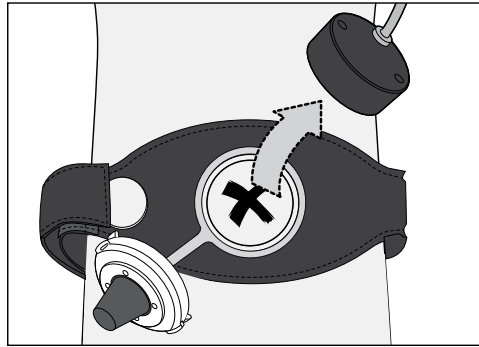

2. Gently remove the transducer from the port. Do not yank the cord! Pulling hard on the cord to remove the transducer may cause the cord to detach from the transducer and require your EXOGEN to be serviced.

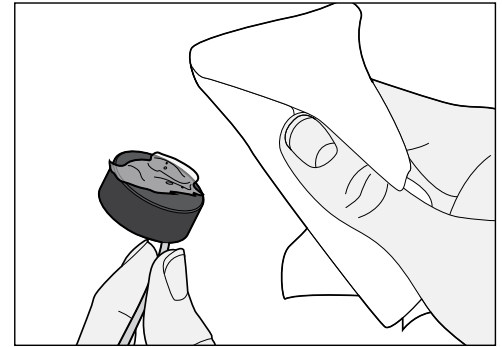

3. Wipe off any gel on the transducer with a soft cloth. You do not need any cleaning fluid.

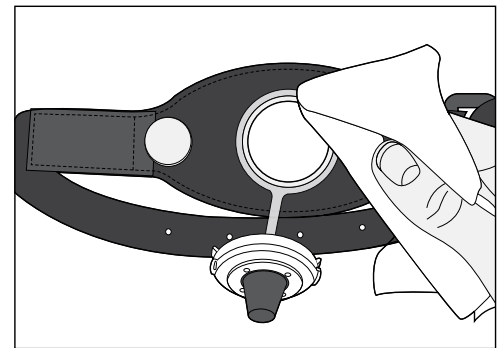

4. Remove the strap and clean any gel from your skin and strap with a soft cloth.
5. Place EXOGEN, the strap and gel back into the carrying case until you are ready to treat again.

## If You Have a Cast

Follow steps 1-3 (previous page), and then do the following instead of step 4:

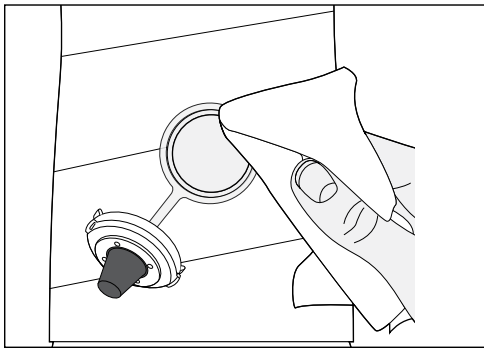

4. Carefully clean any gel from your cast, skin and port with a soft cloth.

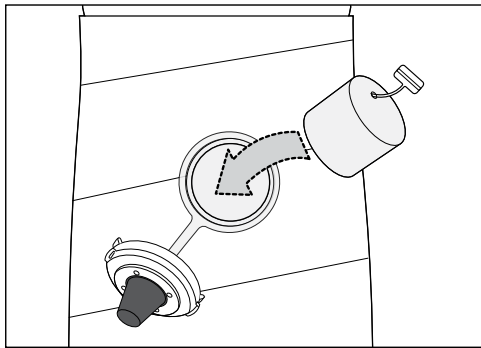

5. Insert the felt plug, with the tab up, into the port. This plug helps prevent swelling in the cast when you are not using EXOGEN.

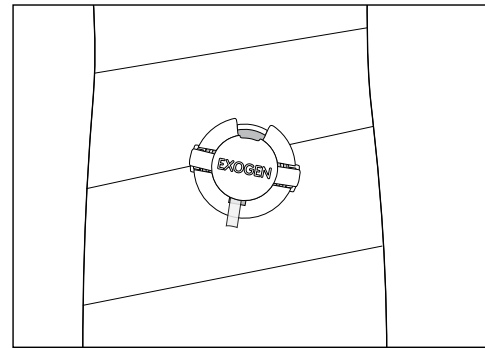

6. Snap the cap shut.
7. Place EXOGEN and the gel back into the carrying case until you are ready to treat again.

# Tracking Your Treatment

## Track Usage

EXOGEN tracks how often you use it. A calendar shows your usage on the screen. There are two parts to the calendar screen. The top part shows a calendar month and the bottom part shows the treatment summary information. See Figure 7.

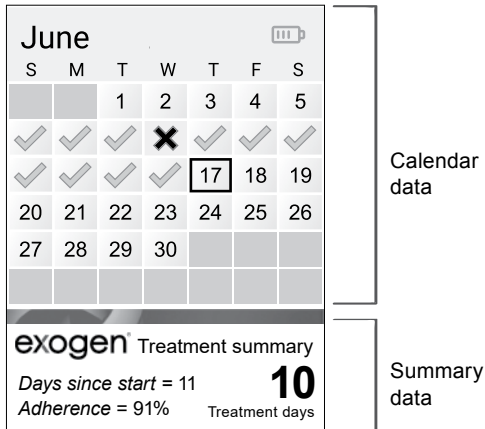

Figure 7 – Treatment Calendar

## Treatment Calendar

The current month is shown when you turn on EXOGEN for a treatment. Today's date will have a purple box around it. EXOGEN will mark your calendar every day with one of the following symbols: X-mark, checkmark, double checkmark\*, or double checkmark plus.\*

Symbol	Name	Description
	X-mark	You did not complete a 20 minute treatment on this day.
	Checkmark	You completed a 20 minute treatment on this day.
	Double checkmark	You completed two 20 minute treatments on this day.
	Double checkmark plus	You completed three or more 20 minute treatments on this day.

\*EXOGEN should be used for only 20 minutes per day, or as prescribed by your doctor.

## Treatment Summary Data

The treatment summary shows your overall use of EXOGEN. The summary data always accounts for all your days of treatment, not just the current month.

Treatment days are the number of days that you have completed a 20-minute treatment. This includes days marked with a checkmark, double checkmark, or double checkmark plus.

Total days are the number of days passed since your first treatment.

The adherence % is the number of treatment days divided by the number of total days.

For example, if you use EXOGEN every day for 60 days, you will have the following numbers:

Treatment days = 60

Days since start = 60

Adherence = 100%

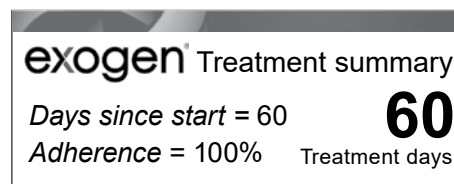

If you have EXOGEN for 60 days, but forgot to treat 10 of those days, your numbers will look like:

Treatment days = 50

Days since start = 60

Adherence = 83%

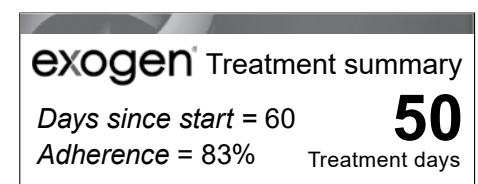

**REMEMBER!** Use EXOGEN every day for 20 minutes, or as directed by your doctor.



## Usage Summary Data

EXOGEN also displays your usage on the screen during your treatment. The Usage Summary Data screens show your overall usage as well as recent consecutive usage.

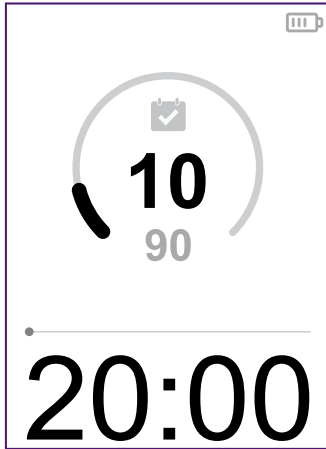

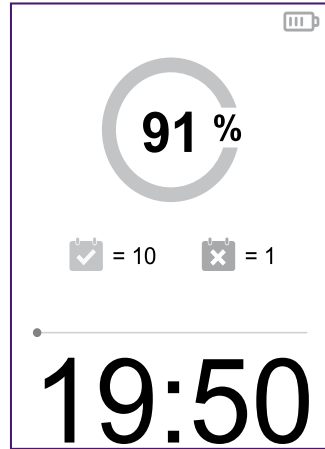

The goal screen will be displayed during your treatment for 10 seconds. This screen displays the number of treatment days above a goal number of treatment days starting at 90. Once the first goal is achieved, a new goal will be displayed.

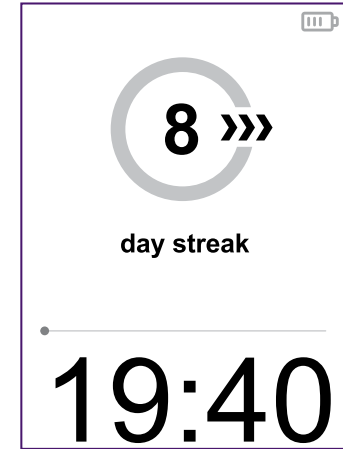

The adherence screen will also be displayed during your treatment for 10 seconds. The adherence percentage is the number of treatment days divided by the number of total days since you began using EXOGEN.



The day streak screen will also be displayed during your treatment for 10 seconds. This screen displays the number of consecutive treatment days that have been completed immediately prior to the current treatment day.

Symbol	Name	Description
	Treatment Days	Day in which at least one full treatment was delivered
	Missed Treatment Day	Day in which zero full treatments were delivered
	Treatment Day Streak	Consecutive Treatment Days in which at least one full treatment was delivered

## Treatment History

After using EXOGEN over time, you may want to view your treatment history month by month. EXOGEN will store up to twelve months of recent treatment history. You can show your treatment history to your doctor. EXOGEN lets you view your treatment history without having to start a treatment. You can start EXOGEN in "Treatment History" mode. You cannot enter "Treatment History" mode when EXOGEN is being charged. To view your treatment history, perform the following steps:

1. EXOGEN must be "OFF" and unplugged from the charger.
2. Press and hold the power button until the Treatment History screen appears.
3. Then, a calendar of the current month of treatment appears for 5 seconds.
4. EXOGEN then shows the previous month of treatment for 5 seconds. EXOGEN will display up to 12 months of previous treatment history. This continues until your most recent twelve months of treatment have been shown. Please note, if you have treated with EXOGEN for fewer than 12 months, the EXOGEN device will only display treatment history for the number of months you have used your device. This could be as few as one or two months. You may exit the Treatment History mode at any time by pressing and holding the button until EXOGEN turns itself off.
5. After the last month displays for 5 seconds, EXOGEN turns itself off.



History start screen

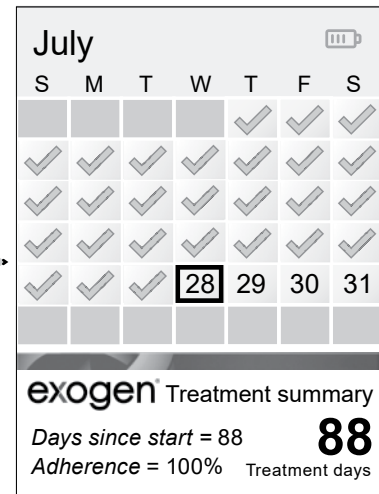

Calendar 1

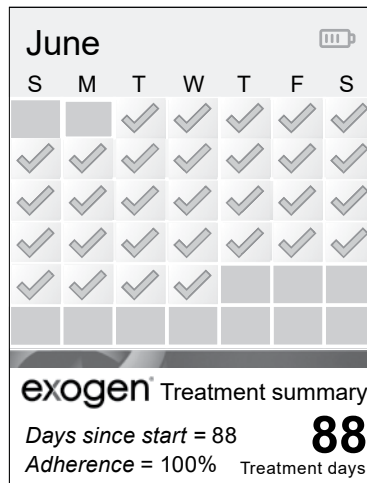

Calendar 2

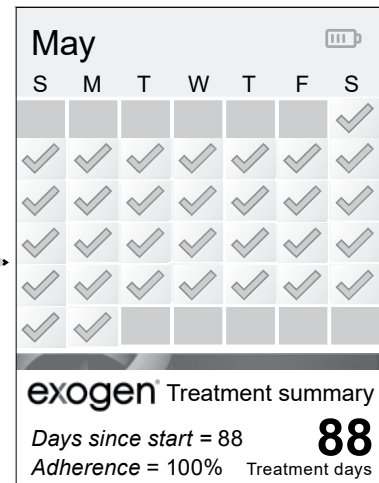

Calendar 3

## Calendar Pause

You can pause the calendar screen to view your treatment history for longer than 5 seconds.

Any calendar screen can be paused. To pause the calendar, perform the following steps:

1. When you see a calendar screen, press the button to pause.
2. The calendar will pause, a pause symbol appears, and the word "PAUSED" flashes.
3. Press the button again to un-pause the calendar and continue.
4. The calendar screen will automatically un-pause after 2 minutes and continue.

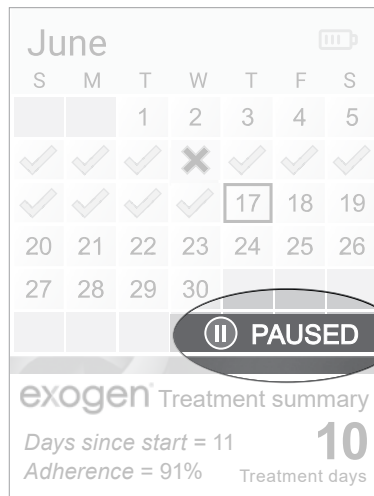

# EXOGEN Care

EXOGEN should be handled with care. Please note the following:

- Use only a clean soft cloth, paper towel, or cotton swab to clean EXOGEN, the transducer and the strap. Do not use cleaning agents or solvents on any of the components of the system
- Do not attempt to modify, disassemble or repair the EXOGEN. There are no user serviceable parts inside EXOGEN
- Exercise care when handling the transducer as rough handling may scratch the transducer face and cause EXOGEN not to work properly
- If any parts of EXOGEN or its accessories are damaged, do not use EXOGEN. Please contact Customer Service at **1-800-836-4080** to return your EXOGEN for servicing
- EXOGEN is classified as an IP-22 device. The IP-22 classification indicates that EXOGEN provides:
  - Protection against the access of fingers or similar objects from the internal components of EXOGEN
  - Protection against the harmful ingress of water into the enclosure of EXOGEN when tilted up to 15° from normal position
- The EXOGEN transducer is classified as an IP-67 component. The IP-67 classification indicates that the transducer is:
  - Dust-tight
  - Will not be damaged by water under defined conditions of pressure and time (up to 1 meter underwater)
- Never put EXOGEN in or under water

## Operating Conditions

### EXOGEN should be operated within:

Ambient temperature range: 5°C to 32°C (41°F to 89°F)

Relative humidity range: 15% to 75% (non-condensing)

Atmospheric pressure range: 700 hPa to 1060 hPa

Interference with proper operation of EXOGEN may occur in the vicinity of equipment such as portable and mobile communication units marked with this symbol . If abnormal operation of EXOGEN is observed, attempt to relocate or reorient EXOGEN in relation to the interfering equipment until the interference stops.

The charger will function with an input voltage range from 100 VAC -240 VAC and has an operating frequency range of 50/60 Hz. The charger output is 5 VDC.

### EXOGEN and accessories should be stored and transported within:

Ambient temperature range: 0°C to 32°C (32°F to 89°F)

Relative humidity range: 15% to 85%

Atmospheric pressure range: 700 hPa to 1060 hPa

If EXOGEN is stored or transported in temperatures outside this range, allow EXOGEN time to come to room temperature for at least 30 minutes before operating. The least favorable working conditions for EXOGEN are +32°C at 75% Humidity.

## Storage

- To prevent damage to EXOGEN and its accessories, store EXOGEN in its carrying case while not in use
- Do not store EXOGEN near radiators or extreme heat
- Do not expose EXOGEN to extreme temperatures or the internal electronic components may be damaged
- As with any home electronic device, protect EXOGEN from impact, exposure to moisture, liquid spills, sand, dirt or debris

After your fracture has healed or prior to long-term storage of EXOGEN, remove the battery to prevent leakage of the battery.

## EXOGEN Expected Service Life

The expected service life of EXOGEN and its accessories is 343 treatments (6860 minutes). Once EXOGEN delivers 343 treatments, it will not provide further treatment.

## Battery and Charging Safety

### Battery

- Do not attempt to replace the lithium-ion battery.
- Do not attempt to replace the lithium-ion battery with non-approved batteries. Incorrect replacement of the battery could result in damage to EXOGEN. The battery should only be serviced by Bioventus trained personnel.
- Be sure to use only the USB battery charger provided with the system. Other battery chargers may cause battery overheating and damage the battery, EXOGEN, the battery chargers or the user.
- Do not use an extension cord with the battery charger as this may cause overheating.
- Do not use the battery charger with other devices as this may damage the battery charger and/or the other device.
- If the battery area on EXOGEN or the battery charger becomes excessively warm, discontinue using and contact Customer Service at **1-800-836-4080**.

### Charging

- Charge the battery to at least 25% capacity (one bar) before attempting to perform a treatment when the battery is used for the first time or after prolonged storage.
- The battery will charge whether EXOGEN is turned off or on.
- If the battery power decreases quickly even after recharging for many hours contact Customer Service at **1-800-836-4080**.
- If the battery charger is damaged, do not attempt to charge the device. Please contact Customer Service.

#### **Do not recharge the battery in any of the following locations;**

- Where the ambient temperature is below 0°C (32° F) or above 45°C (113° F)
- Damp or wet location and/or near water
- Outside (use indoors only)
- Within the reach of small children
- With the battery charger cable stretched across a floor or other areas where people walk that would cause a tripping hazard
- On floor or other area where EXOGEN or the cable may be damaged by people walking on them

## EXOGEN Disposal

EXOGEN is designed for single patient use only. For details on how to dispose of EXOGEN correctly, contact your local government waste disposal agency or Customer Service at 1-800-836-4080.

**Caution:** Dispose of the battery properly to prevent environmental contamination and possible human injury.

**Warning:** Do not throw any part of EXOGEN into fire.

### Removing the Battery for Disposal

Only remove the battery from EXOGEN for disposal. To remove the battery, follow these steps:

1. Make sure EXOGEN is not plugged in to an electrical outlet.



2. Turn EXOGEN screen side down and find the battery door screw.



3. Use a screwdriver to remove the battery door screw.

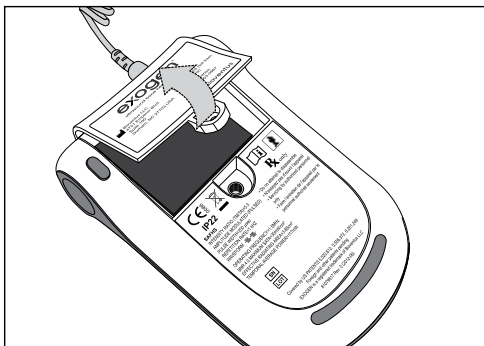

4. Remove the battery door by lifting up at the tab.

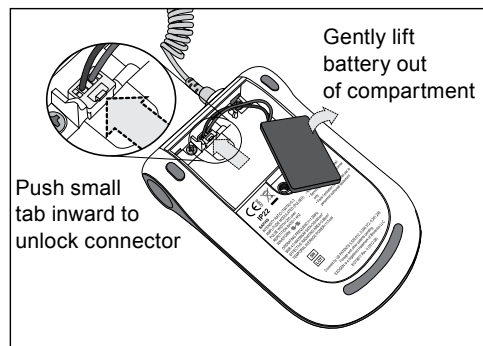

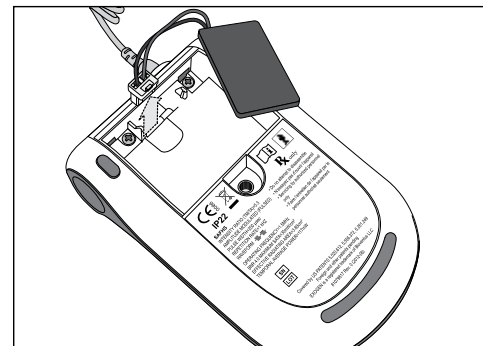

5. Gently lift the battery out of the compartment.
6. Follow the red and black wires to find the battery connector.
7. Push the small tab in and pull up to unlock the battery connector.



8. Remove and properly dispose of the battery according to your local or national refuse laws.

# Troubleshooting

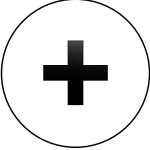
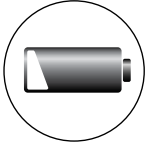
EXOGEN will alert you if something is not working properly. EXOGEN will beep and display an alert screen. See the table below for examples of alerts and what to do if you get an alert. Any serious incident that has occurred in relation to the device should be reported to the manufacturer and the Competent Authority of the Member State in which the user and/or patient is established.

Alerts	What does this mean?	What should I do?
 <p>Add Gel</p>	<p>Gel Error:</p> <p>The countdown timer stops, EXOGEN beeps and displays the yellow "Add Gel" screen.</p> <p>There is not enough gel on the transducer.</p>	<p>Add more gel to the transducer. See "Add Gel and Place Transducer" on page 8.</p> <p>After you add more gel, place the transducer back over the fracture using the strap or cast port. EXOGEN will stop beeping and the countdown timer will restart. If EXOGEN still beeps and the "Add Gel" screen remains, add more gel.</p>
 <p>Low Battery</p>	<p>Low Battery:</p> <p>You are not able to start treatment or view history. EXOGEN beeps and displays the yellow "Low Battery" screen.</p> <p>The battery level is very low. You must charge EXOGEN.</p>	<p>Plug EXOGEN into a power source with the provided charger. You may charge EXOGEN and treat at the same time.</p> <p>See "Charging EXOGEN" on page 5.</p>
 <p>Contact Customer Service</p>	<p>Contact Customer Service:</p> <p>EXOGEN beeps and displays the yellow "Contact Customer Service" screen with a numerical code beneath the symbol.</p> <p>EXOGEN has detected that it is not working properly.</p>	<p>Call Customer Service at <b>1-800-836-4080</b>. Do not try to fix EXOGEN yourself.</p>
 <p>No Remaining Treatments</p>	<p>No Remaining Treatments:</p> <p>EXOGEN beeps and displays the yellow "No Remaining Treatments" screen.</p> <p>EXOGEN has reached the 343 treatment level or the end of its expected life.</p>	<p>If you are still being instructed by your doctor to treat your fracture with EXOGEN, call Customer Service at <b>1-800-836-4080</b> for instructions.</p>

Problems	What does this mean?	What should I do?
<p>Blank screen, EXOGEN does not turn on.</p>	<p>The battery may be completely discharged or the EXOGEN device has malfunctioned.</p>	<p>Plug in charger to EXOGEN and fully charge your battery. If EXOGEN still does not respond, contact Customer Service at <b>1-800-836-4080</b>.</p>
<p>The battery area on EXOGEN or the battery charger gets excessively warm.</p>	<p>The battery or charger is malfunctioning.</p>	<p>Stop using EXOGEN and contact Customer Service at <b>1-800-836-4080</b>.</p>

# CLINICAL STUDIES

## Treatment of Non-union Fractures

### Study design

Three prospectively designed studies, undertaken in the USA, Germany and the Netherlands, were submitted to the FDA<sup>1</sup> as the basis for approval of the EXOGEN Ultrasound Bone healing system to treat established non-unions. The studies had a self-paired control design with each non-union case serving as its own control, and with the prior treatment result of failed orthopedic care as the control compared to ultrasound as the only new treatment. The criterion for the definition of non-union cases was the minimum time from fracture of nine months. The primary efficacy outcome was healed due to EXOGEN treatment, as judged clinically (no pain upon palpation or weightbearing) and radiographically (3 out of 4 cortices bridged).

### Clinical results

Analyzing the data from Germany, the completed cases had a healed rate of 86% (64/74) with a mean time to a healed fracture of 163±9.4 days. The median heal time was 142 days with a range of 53 to 375 days. The mean fracture age for the healed cases was 494 days with a range of 257-6011 days. The scaphoid non-union heal rate of 33% (2/6) was attributable to the three scaphoid non-union failures that were all more than 10 years in fracture age and, therefore, were very difficult and challenging cases. Cases with metal surgical fixation present during EXOGEN treatment such as those with ORIF (Open Reduction Internal Fixation) and those cases with intramedullary rods had an 88% (21/24) and 100% (16/16) healed rate, respectively. The results of this non-union paired design clinical study established the safety and effectiveness of the EXOGEN bone healing system in treating non-unions. This includes cases that had long fracture ages of up to 5 years but suggests that non-unions over 5 years duration may have a decreased response to ultrasound treatment. The results are summarized in Table 1.

Nolte et al.<sup>2</sup>, reporting on the Netherlands study, confirmed the 86% (25/29) success rate and showed the average heal time to be around 5 months without additional intervention. Average

non-union fracture age was 61 weeks. There were high success rates seen with atrophic and oligotrophic non-unions (80% and 92% respectively) where some biological deficiency may contribute to the original non-union. Additionally the application of EXOGEN to hypertrophic non-unions, which might usually be considered as requiring revised treatment to correct fracture instability, was successful in 80% of cases. Success was seen for a range of bones, all types of typical primary fracture management, and across all patient age ranges. For the United States study, the completed cases group had an 82% (352/429) heal rate.

### Other non-union studies:

Frankel and Mizuno<sup>3</sup> in their analysis of the 1,546 USA patient nonunion registry demonstrated that for patients with risk factors that may impair fracture healing, such as substance abuse, diabetes, vascular problems, or steroid use, there was no significant change in the efficacy of the EXOGEN Ultrasound Bone Healing System. Again high success rates were achieved for all bones, regardless of fracture age, but there was a trend towards higher success rates and faster healing with earlier intervention.

Duarte et al.<sup>4</sup> presented data from one of the largest cohorts of patients treated with low intensity pulsed ultrasound (1996). 380 nonresponding delayed and non-unions (averaging 14 months old) were treated with the EXOGEN ultrasound signal and achieved an 85% success rate across a range of bones.

Romano et al.<sup>5</sup> reported on prospective longitudinal studies in infected non-unions and pseudoarthrosis respectively, suggesting high success rates with low intensity pulsed ultrasound in both situations.

Strauss and Gonya<sup>6</sup> described the effects of low intensity pulsed ultrasound on two difficult cases of Charcot non-unions with multiple prior failed surgical procedures. Both cases healed within 5.5 months when treated with the EXOGEN bone healing system.

A number of clinical studies have explored the use of low-intensity pulsed ultrasound in non-union fractures with instrumented fixation, fragility fracture or bone infection. The results have been demonstrated to be comparable to

non-union healing rates in patients without these particular confounding factors. The heal rate among the subject patient populations was 80% (578/719) for instrumented fractures<sup>2,30,52-62</sup>, 92% (145 of 158) for fragility fractures<sup>63</sup>, and 80% (47/59) for infected fractures<sup>2,54,58,64-65</sup> for a combined heal rate of 82%.

## Acceleration of Conservatively Treated Fresh Distal Radius Fractures

### Study design

Placebo-controlled, randomized, double-blind multi-centre study with the prospectively defined primary end-point of a combination of clinical and radiographic healing (4 out of 4 cortices bridged as judged by the blinded principal investigator). 61 patients with conservatively treated cancellous radial fractures were randomized into the EXOGEN treated and control groups (Kristiansen et al.<sup>7</sup>).

### Patient population and demographics

The demographics of the trial participants were comparable across treatment and control groups with regard to age, sex, fracture characteristics, interval between fracture and commencement of fracture, and duration of follow-up.

### Evaluation schedule

Treatment was started within seven days of the fracture, and patients instructed to use EXOGEN until the 10 week follow-up visit. Duration of immobilization in the cast was determined by the site investigator.

Patients were scheduled to return for follow-up at 1, 2, 3, 4, 5, 6, 8, 10, 12 and 16 weeks.

## Clinical Results

EXOGEN treatment accelerated healing by 38% (61±3.4 days in the active group versus 98±5.2 days in the control group; p<0.0001).

The effect of EXOGEN low intensity pulsed ultrasound on fracture reduction during healing was also assessed. The sub-set of fractures which were satisfactorily reduced having presented with at least 10 degrees of negative volar angulation were analyzed. The active group



demonstrated significantly smaller loss of reduction compared to the placebo group ( $p < 0.01$ ).

## Acceleration of Conservatively Treated Fresh Tibial Fractures

### Study Design

Placebo-controlled, randomized, double-blind multi-centre study with the prospectively defined primary end-point of a combination of clinical and radiographic healing (3 out of 4 cortices bridged as judged by the blinded principal investigator). 67 patients with conservatively treated closed or grade-I open, cortical tibia fractures were randomized into the EXOGEN treated and control groups (Heckman et al.<sup>8</sup>).

### Patient population and demographics

The demographics of the trial participants were comparable across treatment and control groups with regard to age, sex, fracture characteristics, interval between fracture and commencement of fracture, duration of follow-up, and days to start weight-bearing.

### Evaluation schedule

Treatment was started within seven days of the fracture, and continued for 20 weeks or until the clinical investigator judged the fracture to have healed. All patients were scheduled for follow-up radiographs at 4, 6, 8, 10, 12, 14, 20, 33 and 52 weeks after the fracture. Clinical follow-up evaluations were performed at the time of any cast change (usually at 6 and 10 weeks) and at the follow-up visit when radiographic evaluation indicated the fracture had healed sufficiently to allow removal of the cast.

## Clinical Results

EXOGEN treatment induced a 38% acceleration in achieving the prospectively defined primary end-point of a combination of clinical and radiographic healing ( $96 \pm 4.9$  days in the active group versus  $154 \pm 13.7$  days in the control group;  $p < 0.0001$ ).

### Analysis of fresh fracture studies:

Cook et al.<sup>9</sup> pooled the data from the tibia and distal radius studies to analyze the impact of low

intensity pulsed ultrasound on the incidence of delayed unions, and on the healing time of smokers. Using a 150 day definition of delayed union, Cook et al.<sup>9</sup> determined that the EXOGEN Ultrasound Bone Healing System had a statistically significant effect ( $p < 0.003$ ) on the rate of delayed unions (treated group 6% versus control group 36%). Cook et al.<sup>9</sup> also demonstrated a significant reduction in the healing time of smokers for fractures of the tibia and distal radius.

### Other fresh fracture studies:

In addition to long bones, the effect of the EXOGEN Ultrasound Bone Healing System on fractures of other types of bone has also been clinically studied. A single center, prospective, randomized, double-blind, placebo-controlled study of 40 scaphoid fractures<sup>10</sup>, demonstrated a statistically significant 31% acceleration in the primary end-point of clinical plus radiographic healing (active 43 days; control 62 days;  $p < 0.01$ ) and 41% improvement in percentage trabecular bridging at 6 weeks (active 81%, control 55%,  $p < 0.05$ ). A smaller ( $n=20$ ) single-center, prospective, randomized, double-blind, placebo controlled study of Jones' fractures<sup>11</sup> showed all actively-treated fractures healed within 56 days whilst only 60% of placebo-treated fractures had healed by 87 days, and 20% had still not healed after 140 days. In addition, the actively-treated group reached pain free status 31 to 70 days earlier than the placebo group, and on average took only half the rehabilitation time.

## Safety

### a. Gross Pathology

Several studies were conducted to assess the safety of EXOGEN as part of the FDA summary of safety & effectiveness. Results from a placebo controlled in-vivo study on rabbits with bilateral midshaft fibular osteotomies showed no deleterious effects of EXOGEN as evidenced by pathological, hematological, and histological analysis<sup>12</sup>.

### b. DNA Analysis

Analysis of the effects of EXOGEN on chromosome of bone marrow cells from a rabbit mid-shaft radius osteotomy reported no

measurable, significant, detrimental effects<sup>13</sup>.

### c. Temperature

EXOGEN's acoustic output is 20 to 100 times less than that of other therapeutic ultrasound devices currently available.

An independent university-based medical expert in ultrasound<sup>14</sup> concluded EXOGEN is incapable of producing temperature elevations greater than 1°C. Such temperature elevations are not considered significant and the potential for detrimental thermal effects is not a concern.

### d. Metals & Implants

Several reference articles have focused on conventional therapeutic ultrasound's effect on surgical metallic implants. Lehman et al.<sup>15</sup> reported that, based on histological studies, ultrasound applied in the presence of metal implants did not produce any untoward effects. In addition, it has been shown that low intensity ultrasound does not compromise the integrity of a standard orthopaedic stainless steel fixation plate<sup>1</sup>. After 30 hours of continuous exposure, no changes or effects could be detected.

**Temperature**—Gersten<sup>16</sup> reported that temperature rises were smaller with metal than with bone at the same depth, and that the presence of metal was not a contraindication to the use of ultrasound.

**Migration**—Lotsova<sup>17</sup> reported that investigations carried out with Kirschner needles, used as fixation in ultrasound-treated patients did not affect migration of the pins or affect the structural integrity of the pins as determined by metallographic analysis.

**Degradation**—Skoubo-Kristiansen and Sommer<sup>18</sup> concluded that as a result of ultrasound treatment no effect was observed on fixation screws or the torques necessary for loosening the screws in an in-vivo study. The compatibility of the EXOGEN Ultrasound signal on bioabsorbable screws has also been investigated in-vitro and clinically. Handolin et al.<sup>19-20</sup> showed treatment with EXOGEN had no effect on the mechanical or molecular properties of biodegradable self-reinforced poly L-lactide screws and thus biocompatibility between the screws and EXOGEN was good, with no effect on the biodegradation rate.

Apart from Handolin et al.<sup>19-20</sup> the studies reported above used ultrasound intensity levels ranging from 0.5 W/cm<sup>2</sup> to 2 W/cm<sup>2</sup> and no untoward effects were noted. These intensities are 16 to 60 times higher than the intensity used in the EXOGEN Ultrasound Bone Healing System. It is reasonable to conclude that metal present in a healing fracture would not affect the safety or effectiveness of the EXOGEN Ultrasound Bone Healing System.

#### **e. Clinical**

No device-related adverse reactions or medical complications related to the use of EXOGEN have been reported during the clinical studies<sup>2-11, 19, 21-37</sup>.

### **Mode of Action**

#### **a. Mode of Action**

The low-intensity pulsed ultrasound delivered by the EXOGEN Ultrasound Bone Healing System is a mechanical stimulus. This has been clearly demonstrated by experimental work on cadavers in which tissue around an osteotomized bone moved in response to the ultrasound signal at a frequency of 1kHz, the same frequency as the pulse of the EXOGEN ultrasound signal. Tissue motion has been calculated to be of the order of 0.5nm, approximately 1000 times less than "micromotion." As well as soft tissue movement, it was demonstrated that the bone moved albeit on a smaller scale<sup>38</sup>. This work shows stimulation with the EXOGEN Ultrasound Bone Healing System provides motion on a nanometer scale, suggesting the mode of action is independent of fixation methods such as casting or external fixation. Mechanical energy is transformed into biochemical energy by transduction at the cell membrane. One family of cell membrane receptors that are responsible for this transduction are integrins. It has been demonstrated that the EXOGEN ultrasound signal stimulates cells through an integrin pathway<sup>39</sup>. Within this integrin pathway, cytoskeletal organization, transcription factor activation, gene upregulation, protein synthesis and increased cell proliferation have all been observed.

#### **b. Review information on fracture healing and bone formation**

Two review articles<sup>25,40</sup> have assessed the clinical and basic science evidence for the EXOGEN Ultrasound Bone Healing System. Their analyses suggested the EXOGEN Ultrasound Bone Healing System induced cellular reactions at each phase of fracture healing from inflammation through to endochondral ossification<sup>33</sup>. In addition, a number of preclinical studies have shown acceleration of bone healing with the EXOGEN Ultrasound signal and increased mechanical properties at the fracture site. Pilla et al.<sup>34,41</sup> in two rabbit bilateral fibular osteotomy placebo-controlled studies, reported statistically significant acceleration of ultrasound treated fibulae versus the placebo side 1.7 and 1.4 times faster, respectively. Wang et al.<sup>42</sup> and Yang et al.<sup>43</sup> reported on ultrasound fracture treatment in a model of bilateral closed femoral shaft fractures made in rats and stabilized by a Kirschner wire, serving as an intramedullary rod. Ultrasound treated fractures were shown to be significantly stronger and stiffer than the controls, showing that the stimulatory effect of ultrasound on fracture repair was not inhibited by the presence of a metallic internal fixation device.

Azuma et al.<sup>44</sup>, through histological analysis and micro-computed tomography, were able to determine that accelerated fracture healing in the ultrasound-treated group was typical of normal bone healing. EXOGEN Ultrasound accelerated early, mid and late stages of fracture healing with maximum impact achieved when applied throughout the healing process. Takikawa et al.<sup>45</sup> studied the impact of the EXOGEN Ultrasound Bone Healing System in a hypertrophic non-union model demonstrating 50% resolution in the active group versus 0% in the control group at 6 weeks.

#### **c. Modes**

Effects on chondrocytes—Chondrocytes have been shown to respond to the EXOGEN signal by an increase in proteoglycan synthesis (mediated by calcium signaling) and the increase in aggrecan mRNA<sup>43,46</sup>.

Response of marrow cells to the EXOGEN ultrasound signal—The EXOGEN signal accelerated the differentiation of mesenchymal cells when cultured in a system designed to promote chondrocytic differentiation<sup>47</sup>.

Periosteal cell response—Human periosteal cell cultures responded to low intensity pulsed ultrasound by increasing expression of alkaline phosphatase, osteocalcin and VEGF. In addition long term treatment (4 weeks of 20-minute daily treatment) increased the level of mineralization in these cultures<sup>48</sup>.

Osteoblast differentiation—MMP13 and alkaline phosphatase are two enzymes key to the process of mineralization. Unsworth et al.<sup>49</sup> demonstrated an increase in both these enzymes in MC3T3-E1 cultures after stimulation with EXOGEN ultrasound. Further evidence that ultrasound affects the mineralization process comes from Saito et al.<sup>50</sup> who demonstrated accelerated calcium accumulation in MC3T3-E1 cultures. Significant increases (8.6-fold and 3.6-fold higher than untreated controls) were seen at day 25 and day 35 respectively. Collectively the findings of these studies demonstrate that in a pre-osteoblastic culture system EXOGEN low intensity pulsed ultrasound accelerates differentiation along the osteoblastic lineage. Animal studies have shown that such effects in a fracture environment can benefit the formation of a mineralized callus, stabilizing the fracture and increasing the strength of the bone.

Clear evidence exists that the EXOGEN Ultrasound Bone Healing System accelerates the healing process at all stages of fracture repair<sup>44,51</sup>. In-vitro evidence supports this by demonstrating effects on various cell types, stimulating proteins involved in various biological processes and demonstrating acceleration of some processes in organ culture.

## Adverse Events

Unlike conventional (physical therapy) ultrasound devices, EXOGEN is incapable of producing harmful temperature increases in body tissue<sup>14</sup>. The ultrasound output intensity of EXOGEN is 30 mW/cm<sup>2</sup> and is typically only 1% to 5% of the output intensity of conventional therapeutic ultrasound devices. The ultrasound intensity is comparable to diagnostic ultrasound (1 to 50 mW/cm<sup>2</sup>), such as the intensities used in obstetrical sonogram procedures (fetal monitoring). In addition, there is no evidence of non-thermal adverse effects (cavitation).

## Complications

No device-related adverse reactions or medical complications related to the use of EXOGEN were reported during the clinical studies. Some patients have experienced mild skin irritation caused by skin sensitivity to the gel. If you feel your skin is sensitive to the gel, you may change the gel to mineral oil lubricant for skin or glycerin. In the distal radius study, one patient complained of pain during treatment but they no longer had the pain by the next follow up visit; and one patient, complaining of pain, withdrew from the study.

**Table 1 Clinical Study results for the FDA reviewed non-union cases – stratification by category variables**

Categorical Variable Prior to Start of SAFHS Treatment	Completed Cases Fisher's Exact Probability†					
	Total	Healed	Failed	%Healed	p-value	
Gender:	Female Male	30 44	28 36	2 8	93% 82%	0.19
Age:	≤17 18-29 30-49 50-64 ≥65	1 12 32 21 8	1 9 27 19 8	0 3 5 2 0	100% 75% 84% 91% 100%	0.52
Weight (kg):	<65 kg 65-80 kg > 80 kg	12 35 27	11 31 22	1 4 5	92% 89% 81%	0.65
Fracture Age:	256-365 Days 366-730 Days 731-1826 Days ≥1827 Days	20 27 17 10	19 24 16 5	1 3 1 5	95% 89% 94% 50%	0.001
Total no. surgical procedures combining initial and subsequent interventions:	0 1 2 ≥3	20 15 24 15	15 12 23 14	5 3 1 1	75% 80% 96% 93%	0.16
Prior days without surgery (days from last surgical procedure to SAFHS start):	≤82 83-365 366-730 ≥731	9 39 12 14	9 34 12 9	0 5 0 5	100% 87% 100% 64%	0.03
Bone:	Tibia/Tibia-Fibula/Fibula Femur Radius/Radius-Ulna/Ulna Humerus Metatarsal Other Foot Bones (calcaneus) Ankle†† Scaphoid Other Hand Bones (metacarpal) Other (4-clavicle, 1-pelvis, 1-rib) ††Tibio-talar arthrodesis	28 13 7 6 4 1 2 6 1 6	26 12 6 5 4 1 1 2 1 6	2 1 1 1 0 0 1 4 0 0	93% 92% 86% 83% 100% 100% 50% 33% 100% 100%	0.03
Long Bones vs Other Bones	Long Bones 28 tibia 13 femur 7 radius 6 humerus 4 metatarsal 1 metacarpal	59	54	5	92%	0.02
Other Bones	1 calcaneus 4 clavicle 1 pelvis 1 rib 6 scaphoid 2 ankle	15	10	5	67%	

Displaced at the start of SAFHS Therapy	Missing No Yes	(5) 56 13	(2) 50 12	(3) 6 1	89% 92%	1.00
Long bone type - Only for long bone cases	Missing Metaphyseal Diaphyseal	(5) 8 46	(3) 6 45	(2) 2 1	75% 98%	0.05
Initial Fracture Type	Missing Closed Open Arthrodesis Osteotomy	(4) 40 22 2 6	(2) 34 21 1 6	(2) 6 1 1 0	85% 95% 50% 100%	0.16
Fixation present at start of and during SAFHS treatment: IM rod; only for long bone	No Cases (N=59)	43	38	5	88%	0.31
Yes	Open reduction No Internal fixation (ORIF) Yes	16	16	0	100%	
External fixation; only for	No Long bone cases (N=59)	50	43	7	86%	1.00
Yes	Conservative No (Cast, splint, brace) Yes	24	21	3	88%	
IM rod, or ORIF, or External	No Fixation, or conservative Yes	50	46	4	92%	0.58
Conservative	No (Cast, splint, brace) Yes	9	8	1	89%	
Fixation, or conservative	Yes	58	51	7	88%	0.44
Yes	IM rod, or ORIF, or External No Fixation, or conservative Yes	16	13	3	81%	
Fixation, or conservative	Yes	10	7	3	70%	0.16
Yes		64	57	7	89%	
Prior failed Lithotripsy Therapy	No Yes	72 2	62 2	10 0	86% 100%	1.00
Smoking Status:	Missing Never smoked Stopped smoking prior to SAFHS start Smoker at SAFHS	(2) 34 10 28	(2) 31 8 23	(0) 3 2 5	91% 80% 82%	0.47
Non-union type:	Missing Atrophic Hypertrophic	(22) 41 11	(17) 36 11	(5) 5 0	88% 100%	0.57

# References

1. Premarket Approval P900009/Supplement 6, Summary of safety and effectiveness data: low-intensity pulsed ultrasound device for the noninvasive treatment of nonunions.
2. Nolte PA, van der Krans A, Patka P, Janssen IMC, Ryaby JP, Albers GHR. Low-intensity pulsed ultrasound in the treatment of nonunions. *J Trauma*. 2001;51(4):693-703.
3. Frankel VH, Mizuno K. Management of nonunion with pulsed, low-intensity ultrasound therapy-international results. *Surg Technol Int*. 2001;X:1-6.
4. Duarte LR. University of Sao Paulo, Brazil, unpublished data presented Societe Internationale de Chirurgie Orthopedique et de Traumatologie (SICOT).
5. Romano C, Messina J, Meani E. Low-intensity ultrasound for the treatment of infected nonunions. In: Agazzi M, Bergami PL, Cicero G, Gualdrini G, Mastorillo G, Meani M, Mintina S, Soranzo ML, editors. *Guarderni di infezione osteoarticolare*. 1999;83-93.
6. Strauss E, Gonya G. Adjuvant low intensity ultrasound in charcot neuroarthropathy. *Clin Orthop Relat Res*. 1998;349:132-138.
7. Kristiansen TK, Ryaby JP, McCabe J, Frey JJ, Roe LR. Accelerated healing of distal radial fractures with the use of specific, low-intensity ultrasound. *J Bone Joint Surg*. 1997;79-A(7):961-973.
8. Heckman JD, Ryaby JP, McCabe J, Frey JJ, Kilcoyne RF. Acceleration of tibial fracture-healing by non-invasive, low-intensity pulsed ultrasound. *J Bone Joint Surg*. 1994;76-A(1):26-34.
9. Cook SD, Ryaby JP, McCabe J, Frey JJ, Heckman JD, Kristiansen TK. Acceleration of tibia and distal radius fracture healing in patients who smoke. *Clin Orthop Relat Res*. 1997;337:198-207.
10. Mayr E, Rudzki MM, Borchardt B, Häusser H, Rüter A. Does pulsed low intensity ultrasound accelerate healing of scaphoid fractures? *Handchir Mikrochir Plast Chir*. 2000;32:115-122.
11. Strauss E, Ryaby JP, McCabe JM. Treatment of Jones' fractures of the foot with adjunctive use of low-intensity pulsed ultrasound stimulation. *J Orthop Trauma*. 1999;13(4):310.
12. Shelev M, Klein MJ. Rabbit gross pathology, hematology, necropsy, and histological study. PMA900009, vol.3, section VI.A.3, 302-351.
13. Cardoso AM, et al. Rabbit bone marrow cell chromosome study. PMA900009, vol. 3, section VI.A.5, 371-393.
14. Ziskin MC. Report on the safety of the Therasonics Medical Systems SAFHS unit, model 2A. PMA900009, vol. 3, section VI.A.1, 209-234.
15. Lehman J, et al. Ultrasonic effects as demonstrated in live pigs with surgical metallic implants. *Arch Phys Med Rehabil*. 1979;483-488.
16. Gersten JW. Effect of metallic objects on temperature rises produced in tissue by ultrasound. *Am J Phys Med*. 1988;37:75-82.
17. Lotsova EI. Effect of ultrasound on the strength of metal fixing pins for fractures and joint injuries. *Mekh Kompoz Mat*. 1979; No. 3, 548-549.
18. Skoubo-Kristensen E, Sommer J. Ultrasound influence on internal fixation with a rigid plate in dogs. *Arch Phys Med Rehabil*. 1982;63, 371-373.
19. Handolin L, Kiljunen V, Arnala I, Pajarinen J, Partio EK, Rokkanen P. The effect of low intensity ultrasound and bioabsorbable self-reinforced poly L-lactide screw fixation on bone in lateral malleolar fractures. *Arch Orthop Trauma Surg*. 2005;125(5):317-21.
20. Handolin L, Pohjonen T, Partio EK, Arnala I, Tormala P, Rokkanen P. The effects of low-intensity pulsed ultrasound in bioabsorbable self-reinforced poly L-lactide screw. *Biomaterials*. 2002;23:2733-2736.
21. Frankel VH. Results of prescription use of pulsed ultrasound therapy in fracture management. *Surg Technol Int*. 1998; VII:389-393.
22. Fujioka H, Tanaka J, Yoshiya S, Tsunoda M, Fujita K, Matsui N, Makino T, Kurosaka M. Ultrasound treatment of nonunion of the hook of the hamate in sports activities. *Knee Surg Sports Traumatol Arthrosc*. 2004;12(2):162-164.
23. Fujioka H, Tsunoda M, Noda M, Matsui N, Mizuno K. Treatment of ununited fracture of the hook of hamate by low-intensity pulsed ultrasound: a case report. *J Hand Surg*. 2000;25(1):77-79.
24. Furue Y. The effect of low-intensity pulsed ultrasound for treatment of nonunion. *Orthopaedic Surgery and Traumatology (Japanese language)*. 2000;43(3):231-235.
25. Hadjiargyrou M, McLeod K, Ryaby JP, Rubin C. Enhancement of fracture healing by low intensity ultrasound. *Clin Orthop Relat Res*. 1998;(355S):S216-229.
26. Katsuki M, Mikami J, Matsuno T. Clinical results of sonic accelerated fracture healing system for upper extremity diseases. *Journal of Japanese Society for Surgery of the Hand*. 2002;19(5):601-605.
27. Lerner A, Stein H, Soudry M. Compound high-energy limb fractures with delayed union: our experience with adjuvant ultrasound stimulation (Exogen). *Ultrasonics*. 2004;42(1-9): 915-917.
28. Mayr E, Frankel V, Rüter A. Ultrasound-an alternative healing method for nonunions? *Arch Orthop Trauma Surg*. 2000;120:1-8.
29. Mayr E, Laule A, Suger G, Rüter A, Claes L. Radiographic results of callus distraction aided by pulsed lowintensity ultrasound. *J Orthop Trauma*. 2001;15(6):407-414.
30. Mayr E, Möckl C, Lenich A, Ecker M, Rüter A. Is low intensity ultrasound effective in treating disorders of fracture healing? *Unfallchirurg*. 2002;105:108-115.
31. Mayr E, Wagner S, Ecker M, Rüter A. Ultrasound therapy for nonunions (pseudarthrosis): three case reports. *Unfallchirurg*. 1999;102(3):191-196.
32. Narasaki K. Low intensity ultrasound treatment of nonunion and delayed union cases. *Orthopaedic Surgery and Traumatology (Japanese language)*. 2000;43(3):225-230.
33. Nolte PA, Klein-Nuland J, Albers GHR, Marti RK, Semeins CM, Goei SW, Burger EH. Low-intensity ultrasound stimulates in vitro endochondral ossification. *J Orthop Res*. 2001;16(2):16-22.
34. Pilla AA, Figueiredo M, Nasser PR, Alves JM, Ryaby JT, Klein M, Kaufmann JJ, Siffert RS. Acceleration of bone-repair by pulsed sine wave ultrasound: animal. Clinical and mechanistic studies. In *Electromagnetics in Biology and Medicine*, ed. by CT Brighton and SR Pollock, San Francisco Press. 331-341, 1991.
35. Sato W, Matsushita T, Nakamura K. Acceleration of increase in bone mineral content by low-intensity ultrasound energy in leg lengthening. *J Ultrasound Med*. 1999;18:699-702.
36. Warden SJ, Bennell KL, McMeekin JM, Wark JD. Acceleration of fresh fracture repair using the sonic accelerated fracture healing system (SAFHS): a review. *Calcif Tissue Int*. 2000;66:157-163.
37. Yoshitaka H, Toshiharu S, Osamu U, Toshifumi K, Kazuhisa B. Effect of low intensity ultrasound on severe open fractures. *Seikei Geka (Orthopaedic Surgery and Traumatology) (Japanese language)*. 2003;46(1):67-73.
38. Greenleaf JF, Kinnick RR, Bronk JT, Bolander ME. Ultrasound induced tissue motion during fracture treatment. Orthopaedic Research Society Annual Meeting. 2005.
39. Zhou S, Schmelz A, Seufferlein T, Li Y, Zhao J, Bachem MG. Molecular mechanisms of low intensity pulsed ultrasound in human skin fibroblasts. *J Biol Chem*. 2004;279(52):54463-9.
40. Rubin C, Bolander M, Ryaby JP, Hadjiargyrou M. The use of low-intensity ultrasound to accelerate the healing of fractures. *J Bone Joint Surg*. 2001;83-A: No. 2, 259,270.
41. Pilla AA, Mont MA, Nasser PR, Khan SA, Figueiredo M, Kaufmann JJ, Siffert RS. Non-invasive low-intensity pulsed ultrasound accelerates bone healing in the rabbit. *J Orthop Trauma*. 1990;4:246-253.
42. Wang SJ, Lewallen DG, Bolander ME, Chao EYS, Ilstrup DM, Greenleaf JF. Low-intensity ultrasound treatment increases strength in a rat femoral fracture model. *J Orthop Res*. 1994;12:40-47.
43. Yang KH, Parvizi J, Wang SJ, Lewallen DG, Kinnick R, Greenleaf JF, Bolander ME. Exposure to low-intensity ultrasound stimulates aggrecan gene expression in a rat femur fracture model. *J Orthop Res*. 1996;14(5):802-809.
44. Azuma Y, Ito M, Harada Y, Takagi H, Ohta T, Jingushi S. Low-intensity pulsed ultrasound accelerates rat femoral fracture healing by acting on the various cellular reactions in the fracture callus. *J Bone Miner Res*. 2001;16(4):671-680.
45. Takikawa S, Matsui N, Kokubu T, Tsunoda M, Fujioka H, Mizuno K, Azuma Y. Low-intensity pulsed ultrasound initiates bone healing in rat nonunion fracture model. *J Ultrasound Med*. 2001;20(3):197-205.
46. Parvizi J, Parpura V, Greenleaf JF, Bolander ME. Calcium signaling is required for ultrasound-stimulated aggrecan synthesis by rat chondrocytes. *J Orthop Res*. 2002;20(1):51-57.
47. Ebisawa K, Hata K, Okada K, Kimata K, Ueda M, Torii S, Watanabe H. Ultrasound enhances transforming growth factor beta-mediated chondrocyte differentiation of human mesenchymal stem cells. *Tissue Eng*. 2004;10(5-6) 921-929.
48. Leung KS, Cheung WH, Zhang C, Lee KM, Lo HK. Low intensity pulsed ultrasound stimulates osteogenic activity of human periosteal cells. *Clin Orthop Relat Res*. 2004;418:253-259.
49. Unsworth JM, Kaneez S, Ridgway J, Fenwick SA, Turp EJ, Chenery D, Harrison AJ. Pulsed low intensity ultrasound enhances mineralization in pre-osteoblast cells. Orthopaedic Research Society Annual Meeting. Washington, 2005.
50. Saito M, Soshi S, Tanaka T, Fujii K. Intensity-related differences in collagen post-translational modification in MC3T3-E1 osteoblasts after exposure to low- and high-intensity pulsed ultrasound. *Bone*. 2004;35:644-655.
51. Gebauer GP, Lin SS, Beam HA, Vieira P, Parsons JP. Low-intensity pulsed ultrasound increases the fracture callus strength in diabetic BB Wistar rats but does not affect cellular proliferation. *J Orthop Res*. 2002;20:587-592.
52. Pigozzi F, Moneta MR, Giombini A, Giannini S DCA, Fagnani F MP. Low-intensity pulsed ultrasound in the conservative treatment of pseudarthrosis. *J Sport Med Phys Fitness*. 2004;44:173-178.
53. Gebauer D, Mayr E, Orthner E RJ. Low-intensity Pulsed Ultrasound : Effects on Nonunions. *Ultrasound Med Biol*. 2005;31(10):1391-1402. doi:10.1016/j.ultrasmed-bio.2005.06.002.
54. Fujishiro T, Matsui N, Yoshiya S, Fujioka H, Tsunoda M, Kurosaka M. Treatment of a bone defect in the femoral shaft after osteomyelitis using low-intensity pulsed ultrasound. *Eur J Orthop Surg Traumatol*. 2005;15(3):244-246. doi:10.1007/s00590-005-0235-9.
55. Jingushi S, Mizuno K, Matsushita T, Itoman M. Low-intensity pulsed ultrasound treatment for postoperative delayed union or nonunion of long bone fractures. *J Orthop Sci*. 2007;12(1):35-41. doi:10.1007/s00776-006-1080-3.
56. Rutten S, Nolte PA, Guit GL, Bouman DE, Albers GHR. Use of low-intensity pulsed ultrasound for posttraumatic nonunions of the tibia: A review of patients treated in The Netherlands. *J Trauma - Inj Infect Crit Care*. 2007;62(4):902-908. doi:10.1097/01.ta.0000238663.33796.fb
57. Schofer MD, Block JE, Aigner J, Schmelz A. Improved healing response in delayed unions of the tibia with low-intensity pulsed ultrasound: Results of a randomized sham-controlled trial. *BMC Musculoskelet Disord*. 2010;11(1):229. doi:10.1186/1471-2474-11-229
58. Hemery X, Ohl X, Saddiki R, Barresi L, Dehoux E. Low-intensity pulsed ultrasound for non-union treatment: A 14-case series evaluation. *Orthop Traumatol Surg Res*. 2011;97(1):51-57. doi:10.1016/j.otsr.2010.09.016
59. Roussignol X, Currey C, Duparc F, Dujardin F. Indications and results for the ExogenTM ultrasound system in the management of non-union: A 59-case pilot study. *Orthop Traumatol Surg Res*. 2012;98(2):206-213. doi:10.1016/j.otsr.2011.10.011
60. Watanabe Y, Arai Y, Tanaka N, Kobayashi M, Matsushita T. Three key factors affecting treatment results of low-intensity pulsed ultrasound for delayed unions and nonunions: Instability, gap size, and atrophic nonunion. *J Orthop Sci*. 2013;18(5):803-810. doi:10.1007/s00776-013-0415-0
61. Uemura T, Okada M, Yokoi T, Shintani K, Nakamura H. Successful Bone Healing of Nonunion After Ulnar Shortening Osteotomy for Smokers Treated With Teriparatide. *Orthopedics*. 2015;38(8):e733-e737. doi:10.3928/01477447-20150804-90
62. Zura R, Della Rocca GJ, Mehta S, et al. Treatment of chronic (>1 year) fracture nonunion: Heal rate in a cohort of 767 patients treated with low-intensity pulsed ultrasound (LIPUS). *Injury*. 2015;46(10):2036-2041. doi:10.1016/j.injury.2015.05.042
63. Data on file from the Post-market Approval Registry for P900009. Bioventus LLC.
64. Romano, CL, Zavatarelli A ME. Biophysical Treatment of Septic Non Unions. *Arch di Ortop Reumatol*. 2006;12-13. doi:10.1007/s10261-006-0097-7
65. Niikura, Takahiro, Lee Sang Yang IT and KM. Low-Intensity Pulsed Ultrasound (LIPUS) Treatment for the Patient with Bone Reconstruction by the Masquelet Technique Using RIA. *J Orthop Trauma*. 2016;30(8):2016.

# Technical Information

## EXOGEN Operating Specifications

---

Ultrasound frequency	1.5 +/- 5% MHz
Modulating signal burst width	200+/- 10% microsecond ( $\mu$ s)
Repetition Rate	1.0+/- 10% kilohertz(kHz)
Duty Factor	20%
Effective radiating area (ERA)	3.88 +/- 10% square cm ( $\text{cm}^2$ )
Temporal average power	117 +/- 30% milliwatts(mW)
Spatial avg.-temporal avg. (SATA)	30+/- 30% mW/cm <sup>2</sup>
Beam non-uniformity ratio (BNR)	4.0 maximum
Battery	3.7 VDC, 700 mAh
Battery Type	Lithium-ion
Input Voltage (USB)	5.0 VDC, 2.6A max.
Beam type	Collimated

---

### The essential performance of EXOGEN includes the following:

- Free from the display of incorrect numerical values (numbers) associated with the ultrasound therapy
- Free from the production of unwanted ultrasound output
- Free from the production of excessive ultrasound output
- Free from the production of unintended or excessive transducer surface temperature

## EXOGEN Classifications

EXOGEN has the following classifications:

- Internally Powered Equipment
- Type BF Applied Part
- EXOGEN device: IP-22
- Transducer: IP-67
- Equipment not suitable for use in the presence of a flammable anaesthetic mixture with air or with oxygen or with nitrous oxide.
- Mode of operation – Intermittent

### Guidance and Manufacturer's Declaration – Electromagnetic Emissions and Immunity Testing

#### Electromagnetic Compatibility Testing

Summary: *Testing Report for:*  
Bioventus LLC.

*Equipment Under Test:* EXOGEN®

*Used for Life Support:* No

*Use in shielded enclosure:* No

### Guidance and manufacturer's declaration – electromagnetic emissions

EXOGEN is intended for use in the electromagnetic environment specified below. The customer or the user of EXOGEN should assure that it is used in such an environment.

Emissions Test	Compliance	Electromagnetic environment – guidance
RF emissions CISPR 11	Group 1	EXOGEN uses RF energy only for its internal function. Therefore, its RF emissions are very low and are not likely to cause any interference in nearby electronic equipment.
RF emissions CISPR 11	Class B	EXOGEN is suitable for use in all establishments including domestic and those directly connected to the public low-voltage power supply network that supplies buildings used for domestic purposes.
Harmonic emissions IEC 61000-3-2	Class A	
Voltage fluctuations / flicker emissions IEC 61000-3-3	Complies	

## Guidance and manufacturer's declaration – electromagnetic immunity

EXOGEN is intended for use in the electromagnetic environment specified below. The customer or the user of the EXOGEN should assure that it is used in such an environment.

Immunity Test	IEC 60601 Test Level	Compliance Level	Electromagnetic environment - guidance
Electrostatic discharge (ESD) IEC 61000-4-2	±8 kV contact ±2 kV, ±4 kV, ±6 kV, ±8 kV, ±15 kV air	±8 kV contact ±2 kV, ±4 kV, ±6 kV, ±8 kV, ±15 kV air	Floors should be wood, concrete or ceramic tile. If floors are covered with synthetic material, the relative humidity should be at least 30%
Electrical fast transient/ burst IEC 61000-4-4	±2 kV 100 kHz repetition frequency	±2 kV 100 kHz repetition frequency	Mains power quality should be that of a typical commercial or hospital environment.
Surge IEC 61000-4-5	±0.5 kV, ±1 kV Line-to-line  ±0.5 kV, ±1 kV, ±2 kV Line-to-ground	±0.5 kV, ±1 kV Line-to-line  Line-to-ground – Not Applicable	Mains power quality should be that of a typical commercial or hospital environment.
Voltage dips, short interruptions and voltage variations on power supply input lines IEC 61000-4-11	0% U <sub>T</sub> ; 0.5 cycle At 0°, 45°, 90°, 135°, 180°, 225°, 270° and 315°  0% U <sub>T</sub> ; 1 cycle  70% U <sub>T</sub> ; 25/30 cycles Single phase: at 0°  0% U <sub>T</sub> ; 250/300 cycle	0% U <sub>T</sub> ; 0.5 cycle At 0°, 45°, 90°, 135°, 180°, 225°, 270° and 315°  0% U <sub>T</sub> ; 1 cycle  70% U <sub>T</sub> ; 25/30 cycles Single phase: at 0°  0% U <sub>T</sub> ; 250/300 cycle	Mains power quality should be that of a typical commercial or hospital environment. If the user of EXOGEN requires continued operation during power mains interruptions, it is recommended that EXOGEN be powered from an uninterruptible power supply or a battery.
Power frequency (50/60 Hz) mag- netic field IEC 61000-4-8	30 A / m 50/60 Hz	30 A / m 50/60 Hz	Power frequency magnetic fields should be at levels characteristic of a typical location in a typical commercial or hospital environment.
Conducted RF IEC 61000-4-6  Radiated RF IEC 61000-4-3	3 Vrms  6 Vrms  (In ISM and amateur radio bands)  150 kHz to 80 MHz  10 V/m 80 MHz - 2.7 GHz 80% AM at 1 kHz	3 Vrms  6 Vrms  (In ISM and amateur radio bands)  150 kHz to 80 MHz  10 V/m 80 MHz - 2.7 GHz 80% AM at 1 kHz	Portable and mobile RF communications equipment should be used no closer to any part of EXOGEN, including cables, than the recommended separation distance calculated from the equation applicable to the frequency of the transmitter. Recommended separation distance:  $d = 1.2 \sqrt{P}$  $d = 1.2 \sqrt{P}$ 80 MHz to 800 MHz  $d = 2.3 \sqrt{P}$ 800 MHz to 2.5 GHz  where P is the maximum output power rating of the transmitter in watts (W) according to the transmitter manufacturer and d is the recommended separation distance in meters (m). Field strengths from fixed RF transmitters, as determined by an electromagnetic site survey, should be less than the compliance level in each frequency range. Interference may occur in the vicinity of equipment marked with the following symbol: 

NOTE U<sub>T</sub> is the a.c. mains voltage prior to application of the test level.

NOTE 1 At 80 MHz and 800 MHz, the higher frequency range applies.

NOTE 2 These guidelines may not apply in all situations. Electromagnetic propagation is affected by absorption and reflection from structures, objects and people.

\*Field strengths from fixed transmitters, such as base stations for radio (cellular/cordless) telephones and land mobile radios, amateur radio, AM and FM radio broadcast and TV broadcast cannot be predicted theoretically with accuracy. TO assess the electromagnetic environment due to fixed RF transmitters, an electromagnetic site survey should be considered. If the measured field strength in the location in which EXOGEN is used exceeds the applicable RF compliance level above, EXOGEN should be observed to verify normal operation. If abnormal performance is observed, additional measures may be necessary, such as re-orienting or relocating EXOGEN.

\*Over the frequency range 150 kHz to 80 MHz, field strengths should be less than 1 V/m.

**Warning:** Portable RF communications equipment (including peripherals such as antenna cables and external antennas) should be used no closer than 30 cm (12 inches) to any part of the EXOGEN device, including cables specified by the manufacturer. Otherwise, degradation of the performance of this equipment could result.

**Warning:** The use of chargers, transducers or cables, other than those supplied, may result in increased radio frequency emissions or decreased electromagnetic immunity of the EXOGEN which may cause EXOGEN to stop working.



## Recommended separation distances between portable and mobile RF communications equipment and EXOGEN

EXOGEN is intended for use in an electromagnetic environment in which radiated RF disturbances are controlled. The customer or the user of EXOGEN can help prevent electromagnetic interference by maintaining a minimum distance between portable and mobile RF communications equipment (transmitters) and EXOGEN as recommended below, according to the maximum output power of the communications equipment.

Rated maximum output power of transmitter – watts (W)	Separation distance according to frequency of transmitter – meter (m)		
	150 kHz to 80 MHz $d = 1.2 \sqrt{P}$	80 MHz to 800 MHz $d = 1.2 \sqrt{P}$	800 MHz to 2.5 GHz $d = 2.3 \sqrt{P}$
0.01	0.12	0.12	0.23
0.1	0.38	0.38	0.73
1	1.2	1.2	2.30
10	3.79	3.79	7.27
100	12.00	12.00	23.00

For transmitters rated at a maximum output power not listed above, the recommended separation distance  $d$  in meters (m) can be estimated using the equation applicable to the frequency of the transmitter, where  $P$  is the maximum output power rating of the transmitter in watts (W) according to the transmitter manufacturer.

**NOTE 1** At 80 MHz and 800 MHz, the separation distance for the higher frequency range applies.

**NOTE 2** These guidelines may not apply in all situations. Electromagnetic propagation is affected by absorption and reflection from structures, objects and people.

Test Report # 104126490ATL-065, 2020-10-26. Testing performed by: Intertek Testing Services NA, Inc., 1950 Evergreen Blvd, Suite 100, Duluth, GA 30096.

## EXOGEN Enclosure Port Immunity to RF wireless communications equipment

Test frequency (MHz)	Band (MHz)	Service	Modulation	Maximum power (W)	Distance (m)	Immunity Test Level (V/m)
385	380 – 390	TETRA 400	Pulse modulation 18 Hz	1.8	0.3	27
450	430 – 470	GMRS 460, FRS 460	FM $\pm 5$ kHz deviation 1 kHz sine	2	0.3	28
710	704 – 787	LTE Band 13, 17	Pulse modulation 217 Hz	0.2	0.3	9
745						
780						
810	800 – 960	GSM 800/900, TETRA 800, iDEN 820, CDMA 850, LTE Band 5	Pulse modulation 18 Hz	2	0.3	28
870						
930						
1 720	1 700 – 1 990	GSM 1800; CDMA 1900; GSM 1900; DECT; LTE Band 1, 3, 4, 25; UMTS	Pulse modulation 217 Hz	2	0.3	28
1 845						
1 970						
2 450	2 400 – 2 570	Bluetooth, WLAN, 802.11 b/g/n, RFID 2450, LTE Band 7	Pulse modulation 217 Hz	2	0.3	28
5 240	5 100 – 5 800	WLAN 802.11 a/n	Pulse modulation 217 Hz	0.2	0.3	9
5 500						
5 785						



## Customer Service

Customer Service is available to answer questions regarding EXOGEN and to handle servicing or disposal needs.

To contact the Service Center in the United States:

Call **1-800-836-4080** (toll free)

General Information:

**1-800-396-4325** (toll free)

In Other Countries:

**00800 02 04 06 08** (toll free)

Bioventus Customer Service  
1900 Charles Bryan Road, Suite 275  
Cordova, TN 38016

### If your EXOGEN needs service, please follow these instructions:

1. Call Customer Service at **1-800-836-4080** and request a Return Authorization (RA) number.
2. Customer Service will provide you with a shipping package to return EXOGEN.
3. Pack EXOGEN in its original packaging. Otherwise pack EXOGEN to prevent movement during shipping.
4. Ship the package to:  
**Bioventus LLC**  
1900 Charles Bryan Road, Suite 275  
Cordova, TN 38016
5. Contact the shipping company to arrange pickup.

## Exclusive Limited Warranty

Bioventus LLC ("Seller") warrants to the original purchaser ("Purchaser") of its EXOGEN Ultrasound Bone Healing System purchased by Purchaser directly from Seller ("System") that the System conforms to Seller's manufacturing specifications. This warranty shall be in effect for a period of one year from the date of purchase.

In the event of a material breach of this warranty, upon timely written notice, Seller will, at its sole option, either repair or replace the System or refund the original purchase price. This will constitute Purchaser's sole remedy. This limited warranty does not extend to any re-sale or other transfer of the System by Purchaser to any other person or entity.

SELLER EXPRESSLY DISCLAIMS ANY AND ALL OTHER WARRANTIES, EITHER EXPRESSED OR IMPLIED, RELATING TO THE SYSTEM OR ITS PERFORMANCE, INCLUDING, WITHOUT LIMITATION, ANY IMPLIED WARRANTY OF MERCHANTABILITY AND ANY IMPLIED WARRANTY OF FITNESS FOR A PARTICULAR PURPOSE.



**Bioventus LLC**

4721 Emperor Blvd Suite 100  
Durham, NC 27703  
USA

1-800-836-4080 / 1-800-396-4325 (toll free)  
1-919-474-6700  
[www.exogen.com](http://www.exogen.com)

© 2023 Bioventus LLC

Bioventus, the Bioventus logo and EXOGEN  
are registered trademarks of Bioventus LLC.

 **bioventus**<sup>®</sup>  
*Innovations For Active Healing*

81087030 Rev. G 2023-04